

Ignis II Operational Manual

DJI M600 Variant

Hardware Version v2.0

Firmware Version 68+

Android App Version 2.8.0

Drone Amplified, INC

IGNIS II



DRONE AMPLIFIED

Contents

1	General	7
1.1	Overview	8
1.2	Size and Weight	9
1.3	Battery and Power	10
1.4	Safety Systems	10
1.5	Android App	10
1.6	Control Bar	12
1.7	LEDs	12
1.8	Error Messages	13
1.9	Environmental Limitations	17
1.10	Ignition Spheres and Fluid	17
1.11	Antifreeze Jug Pump Setup	18
1.12	Storage and Transport	19
1.13	Warranty	20
2	Supporting Equipment	20
2.1	Camera	20
2.2	Laptop with DJI Assistant 2	20
2.3	Generator	20
2.4	Tarp	21
2.5	Antenna Improvements	21
3	Normal Procedures	22
3.1	Preflight Inspection Checklist	23
3.2	Matrice 600 Pro Preflight Inspection Checklist	24
3.3	Starting Dropping and Ignitions Checklist	25
3.4	Stopping Ignitions Checklist	26
3.5	Reloading Between Flights Checklist	26
3.6	Post Flight Inspection Checklist	26
3.7	Preparing for Storage Checklist	27
4	Amplified Normal Procedures	28
4.1	Preflight Inspection Checklist	28
4.1.1	Ignition, Flight Plan, and Emergency Procedures	28

4.1.2	Environmental Conditions and Forecast	28
4.1.3	Inspect for Visible Damage	28
4.1.4	Hatches	29
4.1.5	Dropper Attached to Hopper	29
4.1.6	Battery Install	30
4.1.7	Hopper Attached to Drone	31
4.1.8	Hopper Cable Connected to Drone	32
4.1.9	Disarm Ignis	32
4.1.10	Emergency Release Dials	33
4.1.11	DJI Mode Set to P or F	33
4.1.12	Battery Connect	33
4.1.13	Verify Puncture Motion	34
4.1.14	Start Ignis App	34
4.1.15	Ignis App Ignis Setup	35
4.1.16	Ignis Battery Level	36
4.1.17	Injection Amount	36
4.1.18	Reservoir and Pumps	36
4.1.19	Dropper Needle	39
4.1.20	Drone Preflight Inspection	40
4.1.21	(OPTIONAL) Start Test Ignitions	40
4.1.22	Stop Dropping	41
4.1.23	Check Ignis Status in App	41
4.1.24	Create Geofence	41
4.1.25	Fill Hopper	42
4.1.26	Ready for Takeoff	43
4.2	Starting Dropping and Ignitions Checklist	43
4.2.1	Arm Ignis	43
4.2.2	Check Ignis Status	43
4.2.3	Ensure Drop Area Clear and Safe	43
4.2.4	Press Start Dropping button in App	43
4.2.5	Check Ignis Status	44
4.3	Stopping Ignitions Checklist	45
4.3.1	Press Stop Dropping button in App	45
4.3.2	Check Ignis Status	45
4.3.3	Disarm Ignis	45
4.4	Reloading Between Flights Checklist	46

4.4.1	Disarm Ignis	46
4.4.2	Emergency Release Dials	46
4.4.3	Ignis App Ignis Setup	46
4.4.4	Ignis Battery Level	48
4.4.5	Reservoir and Pumps	48
4.4.6	Drone Preflight Inspection	48
4.4.7	(OPTIONAL) Start Test Ignitions	49
4.4.8	Stop Dropping	49
4.4.9	Fill Hopper	50
4.4.10	Ready for Takeoff	50
4.5	Post Flight Inspection Checklist	50
4.5.1	Drone Safe	50
4.5.2	Slipper Block	51
4.5.3	Ignis Battery	51
4.5.4	Inspect for Visible Damage	51
4.6	Preparing for Storage Checklist	51
4.6.1	Remove Needles from Dropper and Store	51
4.6.2	Separate Dropper from Hopper	52
4.6.3	Clean System	52
4.6.4	Empty Reservoir and Pumps	53
4.6.5	Flush With Water	54
4.6.6	Disconnect Battery	55
4.6.7	Remove Battery	56
4.6.8	Inspect for Visible Damage	56
4.6.9	Store in Case	56
5	Emergency Procedures	57
5.1	Communication Failure Checklist	57
5.2	In-Flight Fire Checklist	57
5.3	Stuck Ignition Sphere After Landing Checklist	57
6	Amplified Emergency Procedures	58
6.1	Communication Failure Checklist	58
6.1.1	Stop Ignitions and Dropping	58
6.1.2	Alert Operators and Bystanders	58
6.1.3	Visually Verify Dropping Stopped	58
6.1.4	Return Drone to Landing Zone and Land	58

6.1.5	Perform Post Flight Inspection	59
6.2	In-Flight Fire Checklist	59
6.2.1	Check for In-Flight Fire	59
6.2.2	Disarm Ignis	59
6.2.3	Fly Over Safe Ignition Area	59
6.2.4	Trigger Dropper Emergency Ejection	59
6.2.5	Return Drone to Landing Zone and Land	59
6.2.6	Perform Post Flight Inspection	60
6.3	Stuck Ignition Sphere After Landing Checklist	60
6.3.1	Remove Needle Assemblies	60
6.3.2	Trigger Dropper Emergency Ejection	60
6.3.3	Battery Disconnect	60
6.3.4	Manually Remove Stuck Ignition Sphere	60
7	Ignis Android App	61
7.1	System Requirements	61
7.2	Privacy and Versions	62
7.3	Main Menu	63
7.3.1	First Time Registration	63
7.3.2	Connecting the Remote Controller	64
7.4	Settings	64
7.5	Download Maps	66
7.5.1	New Offline Region	67
7.5.2	Managing Regions	69
7.5.3	Elevation Data	70
7.6	Map Overlays	70
7.7	Drone Setup	74
7.7.1	Camera Settings	77
7.7.2	Remote Controller Settings	79
7.8	Flight Logs	80
7.9	Ignis Setup	80
7.9.1	Connection Options	80
7.9.2	Bluetooth Settings	81
7.9.3	Connecting through Bluetooth	81
7.9.4	Connecting through the Drone	83
7.10	Flying	84

7.10.1	Map Menu	87
7.10.2	Auto Takeoff / Auto Landing Menu	90
7.10.3	Camera Control	91
7.10.4	Battery Menu	97
7.10.5	Ignis Menu	97
7.10.6	Geofencing	102
7.10.7	Waypoints Menu	102
7.10.8	Ignition Lines	110
7.11	Privacy Mechanisms	111
8	Service and Maintenance	112
8.1	Every Flight Maintenance	112
8.2	Daily Maintenance	113
8.3	Periodic Maintenance	113
8.3.1	Inspecting Screws	113
8.3.2	Cleaning Dropper	114
8.3.3	Replacing A Needle	116
9	Installation on DJI Matrice 600	119
9.1	DJI Channel Expansion Kit Installation	119
9.2	Interface Cables	119
9.3	DJI Software Configuration	122
9.4	DJI Onboard SDK Activation	124

1 General

This manual covers the operation of the Ignis system with the following configuration:

- Hardware version v2.0
- Firmware version 68+
- Android App version 2.8.0

Ensure that you are using the proper manual for the version of your system.

This section provides a general overview and discusses the requirements and limitations of the system. The following sections provide checklists for normal operation (Section 3) and emergency procedures (Section 5). The checklist items utilize a standard challenge-response type format with any special notes or warnings included after the checklist item, such as:

1. Challenge: RESPONSE

WARNING: Location of warnings or notes

In addition, Sections 4 and 6 provide amplified normal and emergency procedure checklists, respectively, with additional detail and instructions. These should be thoroughly read before operation. Finally, Section 8 discusses required service and maintenance and Section 9 discusses initial installation of Ignis on a DJI Matrice 600.

1.1 Overview

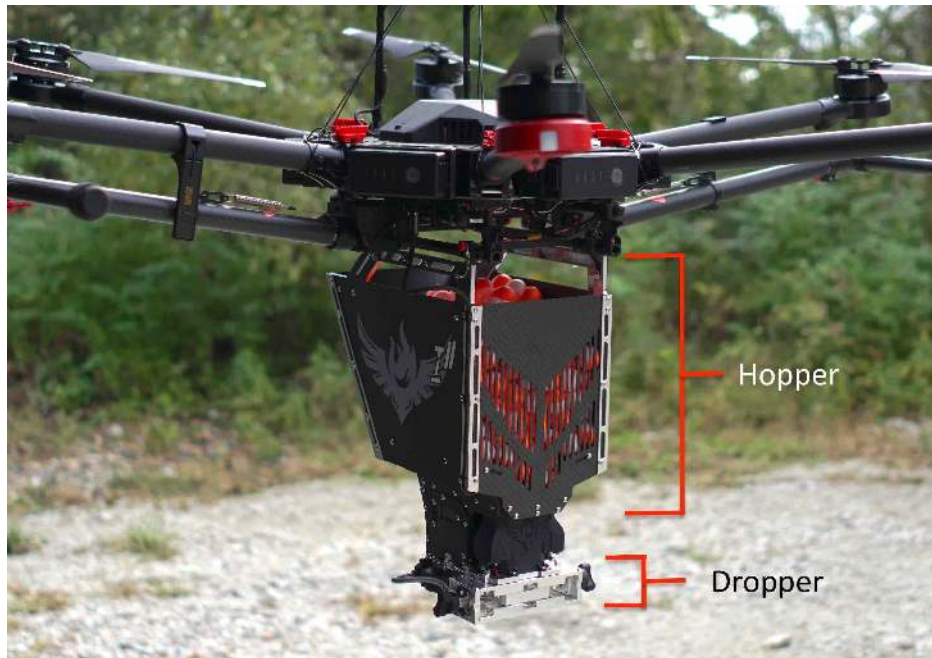

Figure 1: Overview of the Ignis 2 system.

The Ignis system is shown in Figure 1. The top component of it is called the Hopper and holds the ignition spheres. The bottom component is called the Dropper and performs the puncturing and injection of the ignition spheres. The Dropper has a dual-mechanism with two sides, A and B, to allow dropping of ignition spheres at a maximum rate of approximately 120 ignition spheres per minute.

This manual covers the operation of the Ignis when used with a DJI Matrice 600 (M600). It connects to the mounting rails of the M600 and receives commands over communication link from the M600 controller. The Ignis system includes a number of safety systems. This includes onboard monitoring of the system status, onboard sensors, the ability to detach the Dropper remotely, and integrates camera feed for enhanced awareness. See the following sections for details on connecting and using the Ignis system. For first time installation of Ignis on the M600, see Section 9.

This manual provides standard checklists for typical operation and conditions. In addition to following the guidelines in this manual, we recommend:

- Integrating and modifying these checklists based on your specific operating setup and conditions.

- Setting up the drone operational area away from the ignition area, but at a location that can easily be defended in case of fire.
- Have fire extinguishing and fire safety equipment and processes at the drone operational area.
- Be aware of where the drone may fly in case the drone loses communication and performs an automatic return to home (if configured to do so).
- Be aware of your surroundings and to maintain visual line of sight of both the drone and the ignition area.
- Abide by any and all recommendations from the drone manufacturer.
- Follow all fire and drone operational recommendations and best practices.
- Follow all federal, state, and local regulations.

1.2 Size and Weight

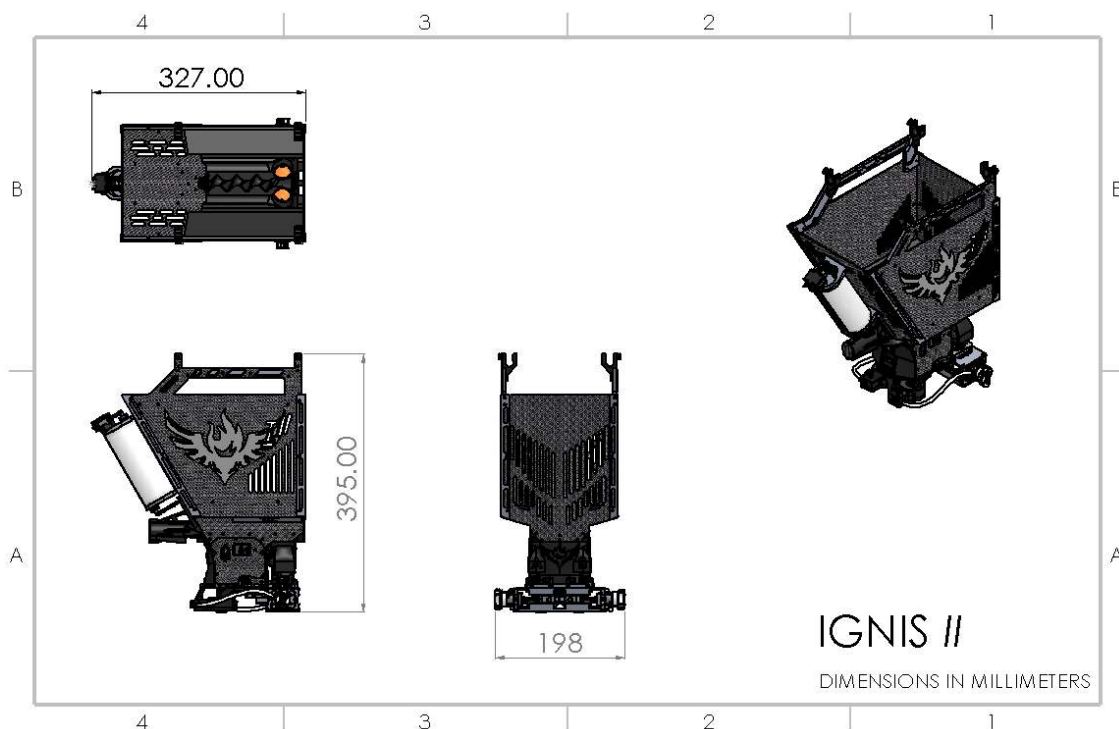

Figure 2: Dimensions of the Ignis 2 system.

The Ignis 2 system is approximately 20 x 33 x 40 cm as shown in Figure 2. With no ignition spheres or antifreeze, the system weighs 2.02kg. With a full load of 400 ignition spheres and antifreeze, the total weight is 4.015kg.

1.3 Battery and Power

The Ignis 2 requires a separate 2 Cell LiPo battery (nominal voltage of 7.4V) with a standard XT60 connector¹. Always use the batteries provided with Ignis 2 or a battery of similar kind and quality.

For best performance, the battery voltage should be above 7.0V during operation and we do not recommend operations below 6.8V. A fully charged 2200mAh battery should allow for over 2000 injections before dropping below 6.8V. However, temperature and operational conditions can have a significant impact on the number of injections per battery charge. We always recommend checking the battery voltage before flights (see Section 4.1.16).

1.4 Safety Systems

Ignis contains numerous safety features to ensure safe and reliable operation and before delivery, each Ignis component undergoes rigorous individual tests and quality control, and every system is tested in the factory after completion. Ignis contains more than a dozen sensors and independent processors to ensure that each operation, from the puncturing to the injection, is proceeding properly. The system continuously monitors motor speed, current, and temperatures to make sure that all systems are operating correctly. Custom designed needles, that are reinforced and supported at the injection point, reduce any risk of bent or clogged needles and software monitors quickly detect these conditions and notify the user. Finally, Ignis contains an ejection system that allows the detachment of the Dropper from the Hopper in the case of an emergency.

1.5 Android App

Ignis is primarily controlled from a custom Android app we have developed. This app integrates software to control a DJI drone, online and offline satellite maps, and control of Ignis to allow safe and easy aerial ignitions anywhere. The app can be used to control Ignis over a convenient short-range Bluetooth connection that can be used without connecting

¹One such example is https://www.amazon.com/Turnigy-2200mAh-Lipo-Pack-XT60/dp/B07F8KP7FS/ref=sr_1_4?keywords=2s+lipo+2200mah+turnigy&qid=1570554570&sr=8-4

Ignis to the drone. During flight, the app controls Ignis over the radio connection between the remote controller and the drone, which can transmit signals up to 5 km.

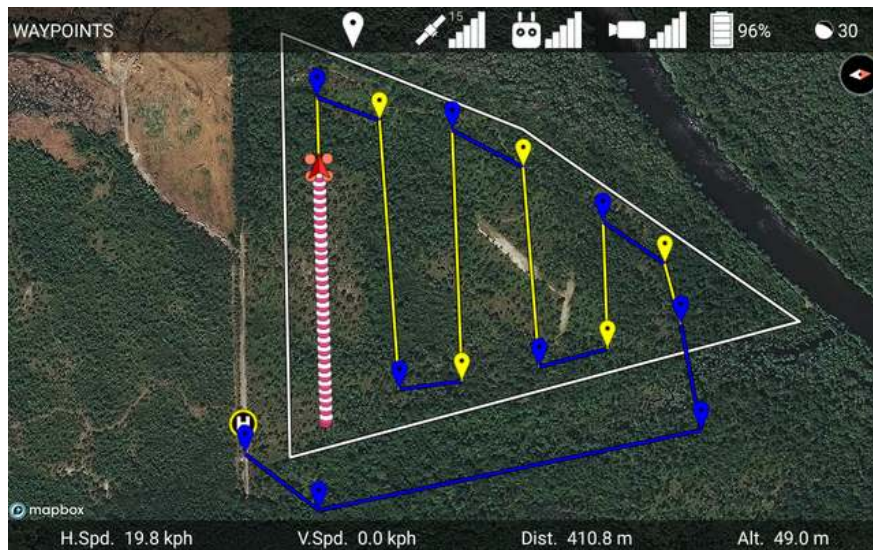

Figure 3: Android app being used to ignite burn lines.

The app displays the current status of Ignis and can be used to start and stop dropping, or trigger an emergency release if necessary. The app can be used to perform more precise ignition patterns by touching the map to place waypoints, and then specifying which portions of the path Ignis should drop along. The app will direct the drone to autonomously fly along the path, and the app will automatically start and stop Ignis's dropping. As a failsafe, if Ignis loses connection with the app, it will automatically stop dropping.

The app can also connect to Ignis through Bluetooth for easy setup and configuration while on the ground. The Bluetooth transmitter has a theoretical 300ft range, but in practice communication is limited beyond 50 ft.

See section 7 for a full description of the app.

1.6 Control Bar



Figure 4: Ignis control switches.

Physical safety switches are also incorporated onto a switch bar attached to the remote controller. This includes switches to manually trigger an emergency release, as well as an Arm/Disarm switch. While the Arm/Disarm switch is in the Disarm position, Ignis will not drop ignition spheres for any reason.

1.7 LEDs

Feedback on the current status of the system is provided through the app and by an indicator LED on the rear of Ignis 2. Table 1 outlines the status information from the LEDs. Table 1 outlines the status information from the LEDs.

Table 1: LED Status Indicators

LED	Status
Green Slow Blink	Ready
Green Fast Blink	Dropping
Blue Blink	Injecting
Red Blink	Error

1.8 Error Messages

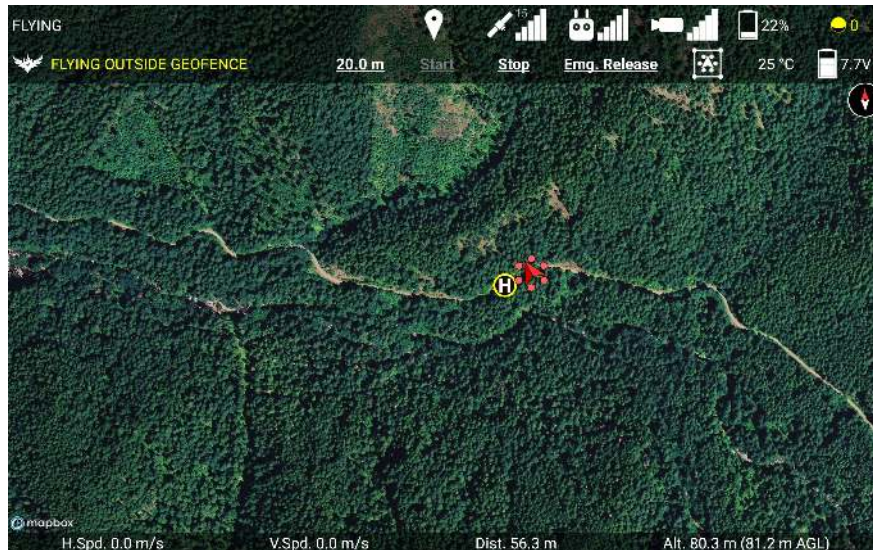

Figure 5: Ignis status display in app during flight, showing that Ignis is currently flying outside of a geofence.

When Ignis is connected to the app, it will display a message indicating its current state. If Ignis encounters an error, the red light on Ignis will blink. Check the app to identify the cause of the error.

If Ignis encounters an error, dropping will automatically stop and Ignis will perform recovery operations to return to a safe state. Dropping cannot be restarted until the error is resolved.

The following is a list of the status messages that can be displayed in the app:

HIGH TEMP ... Ignis's temperature sensor is detecting a high temperature above the injection chamber. An ignition sphere may have caught fire inside the dropper. Trigger an emergency release to separate the dropper from the rest of the aircraft. The ellipsis would display other information about Ignis's status.

IDLE Ignis is currently idle, and has no errors to report.

IDLE (STOPPED B/C ...) Ignis is currently idle, but stopped dropping because of an error. The ellipsis would display the reason why Ignis stopped. Try restarting dropping.

FILLING Ignis is currently filling, and has no errors to report.

FILLING (STOPPED B/C ...) Ignis is currently filling, but stopped dropping due to an error. The ellipsis would display the reason why Ignis stopped. Try restarting dropping.

DROPPING Ignis is dropping.

DROPPING AND FILLING Ignis is dropping, and one or two syringes are refilling. During this period, fewer ignition spheres will be dropped.

DISARMED BY CONTROL BAR The control bar Arm/Disarm switch is in the Disarm position. The switch must be moved to the Arm position in order to start dropping.

FLYING OUTSIDE GEOFENCE Dropping was disabled because the drone is flying in an area that is not enclosed by a geofence. Fly back inside the geofence, or modify the geofence to include the current flight area.

LOW BATTERY Ignis battery voltage dropped below a safe level (11.4 V on Ignis 1, 6.6 V on Ignis 2). Use the app to check that the battery voltage is above this safe level. If it is, and you don't need to drop many more ignition spheres, attempt to restart dropping. Otherwise, land and replace the battery. If Ignis is idle and the battery is close to or lower than the safe level, then dropping is not recommended, as the battery voltage will likely dip below the safe level while Ignis is puncturing an ignition sphere, which will trigger this error again.

NO CONNECTION TO IGNIS The app is not receiving messages from Ignis, and has disabled dropping. Reconnect the app to the controller. You will also see this message if you have not activated the Onboard SDK (See section 9.4).

LOST CONNECTION TO APP Ignis stopped receiving messages from the app, and disabled dropping. Reconnect the app to the controller.

WRONG DRONE MODE Remote controller was switched to mode A. Or, the drone lost connection to the remote controller. Switch the remote controller into mode P or F. Regain radio connection between the controller and the drone. This error may also occur if the drone's configuration in DJI Assistant 2 is incorrect. Verify the configuration in DJI Assistant 2 matches the configuration in 9.3.

LOST CONNECTION TO DRONE Ignis is not receiving any signals or messages from the drone. Check that the USB cable from Ignis is connected to the drone.

LOST DRONE PWM Ignis is no longer receiving PWM signals from the drone. Check that the green-wrapped cable is plugged into the flight controller.

LOST DRONE PWM 0 Ignis is no longer receiving one of the PWM signals from the drone. Check that the green-wrapped cable is plugged into the flight controller, and none of the wires are broken.

LOST DRONE PWM 1 Ignis is no longer receiving one of the PWM signals from the drone. Check that the green-wrapped cable is plugged into the flight controller, and none of the wires are broken.

LOST DRONE PWM 2 Ignis is no longer receiving one of the PWM signals from the drone. Check that the green-wrapped cable is plugged into the flight controller, and none of the wires are broken.

LOST DRONE DATA Ignis is no longer receiving messages from the drone's API port. Check that the blue-wrapped cable is plugged into the flight controller.

LOST CONNECTION TO DROPPER Ignis lost connection with one or all of its sub-boards on the dropper. Check that the USB cable between the hopper and the dropper is connected.

INJECTION A COMMS TIMEOUT Ignis lost connection with the A-side injection sub-boards on the dropper. Check that the USB cable between the hopper and the dropper is connected.

INJECTION B COMMS TIMEOUT Ignis lost connection with the B-side injection sub-boards on the dropper. Check that the USB cable between the hopper and the dropper is connected.

PUNCTURE COMMS TIMEOUT Ignis lost connection with the puncture sub-boards on the dropper. Check that the USB cable between the hopper and the dropper is connected.

EMERGENCY RELEASE TRIGGERED The emergency release has been triggered. Dropping is disabled until you power-cycle Ignis.

S1 NOT CCW Dropping is disabled because the knob on the control bar labeled "S1" is not twisted counter-clockwise all the way. This knob is used to trigger the emergency release, and Ignis will not allow dropping until this knob is ready. An emergency release

is triggered when S1 and S2 are twisted all the way clockwise within 4 seconds of each other in order.

S2 NOT CCW Dropping is disabled because the knob on the control bar labeled “S2” is not twisted counter-clockwise all the way. This knob is used to trigger the emergency release, and Ignis will not allow dropping until this knob is ready. An emergency release is triggered when S1 and S2 are twisted all the way clockwise within 4 seconds of each other in order.

HATCH MOTION ERROR Dropping was stopped because one of the hatches had trouble moving. An ignition sphere may have jammed the hatch. Try restarting to see if the jam has been cleared. If the problem persists, land and inspect the hatches.

MOVE TIMEOUT Dropping was stopped and disabled because one of the injection or puncture motors had trouble moving. Dropping cannot restart until Ignis is power-cycled. Land and inspect the injection and puncture motors. This message will only appear on older versions of Ignis.

INJECTION A MOTION ERROR Dropping was stopped and disabled because the A-side injection motor had trouble moving. Dropping cannot restart until Ignis is power-cycled. Land and inspect the motor.

INJECTION B MOTION ERROR Dropping was stopped and disabled because the B-side injection motor had trouble moving. Dropping cannot restart until Ignis is power-cycled. Land and inspect the motor.

PUNCTURE MOTION ERROR Dropping was stopped and disabled because the puncture motor had trouble moving. Dropping cannot restart until Ignis is power-cycled. This error could lead to an in-flight fire if Ignis was not able to remove an injected sphere. Use the camera and temperature sensor to monitor for an in-flight fire and use the emergency release in that event. Land and inspect the motor.

UNKNOWN ERROR Dropping was stopped because of an error that the app did not understand. Try to restart dropping. Check that you are using the latest version of the app.

UNKNOWN HARD ERROR Dropping was stopped because of an error that the app did not understand, and cannot be restarted until Ignis is power-cycled. Land and inspect Ignis. Check that you are using the latest version of the app.

If these troubleshooting steps do not resolve the issue, contact Drone Amplified for support.

1.9 Environmental Limitations

The Ignis system has been designed to operate under the following conditions:

- System temperatures ranging from 5°C to 40°C.
- No precipitation.
- Humidity under 90% and non-condensing on the surface of Ignis.
- Winds within the operational limits of the drone carrying Ignis, but no greater than 15m/s.

Caution should be exercised when performing ignitions under high winds and/or at higher altitudes to ensure that the ignition spheres drop on target and are not blown out of the ignition area.

Operations outside of these limits are untested, add risk, and may endanger property and persons. Special care must be taken to ensure that temperatures are not inadvertently exceeded. For instance, leaving Ignis in its storage case in the sun can cause temperatures to be exceeded, even when the ambient temperature is significantly lower. Similarly, moisture and temperatures can vary significantly based on drone altitude.

1.10 Ignition Spheres and Fluid

The Ignis system is designed to use standard Dragon Egg spheres <https://www.sei-ind.com/products/fire-ignition-spheres/>. The Ignis 2 Hopper holds up to 400 ignition spheres. Use with other ignition spheres is not supported and may cause damage to the equipment, drone, or uncontrolled fires.

The Ignis injects ethylene glycol (common automotive antifreeze) into the ignition spheres. After injection, the ignition spheres typically will ignite within 20-40 seconds, although this time is highly variable based on the ambient temperature (longer times at colder temperatures, sometimes as long as 2 minutes when near freezing).

The amount of antifreeze Ignis injects is fully customizable and can be configured in the app (see Section 4.1.17). Injection amounts between 0.3-0.5ml works well under most conditions, although variability in antifreeze composition can impact the results and require adjustment of this parameter. We recommend testing under controlled conditions to ensure

the results are as expected whenever changing antifreeze types or when there are significant changes to the ambient temperature.

1.11 Antifreeze Jug Pump Setup

Refilling Ignis with antifreeze is made faster and easier by using the included hand pump and jug mount. To prepare to use the setup, start by removing the factory cap from the jug of antifreeze and installing the customized cap by inserting the tube with pickup clunk attached into the jug first (Figure 6).



Figure 6: Put pickup clunk and tube into jug first and tighten cap.

The custom cap has been tested with most of the common 1 gal jugs of antifreeze available but is not guaranteed to fit all possible brands. Tighten the cap onto the jug. Secure the pump mounting bracket by snapping the front around the cap and zip-tying the rear to the jug handle as shown in Figure 7. Connect the red marked line from the fill coupler to the red marked port on the hand pump. Finally connect the remaining line from the cap to the remaining port on the hand pump.

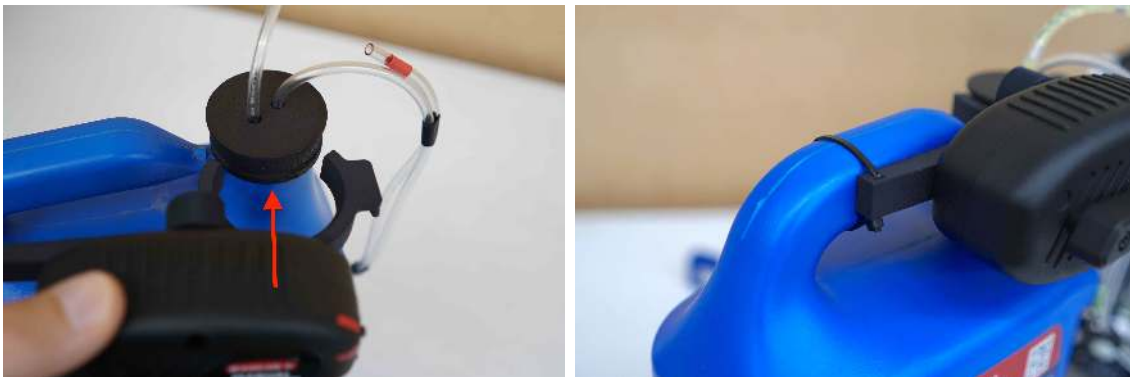

Figure 7: Snap pump mounting bracket around cap and zip-tie the other end to the handle.

The coupler stores on the two pins protruding from the front of the pump mounting bracket as shown in Figure 8.



Figure 8: The coupler stores on the front of the pump mounting bracket when not in use.

1.12 Storage and Transport



Figure 9: Ignis 2 storage container and parts.

Before storage and transport, the Ignis system should be prepared as outlined in Section 4.6. Figure 9 shows the storage container and parts as typically shipped. The system should always be stored and transported in its original transport case. Do not transport or store the Ignis system mounted on the drone, as this may result in damage to the drone or Ignis system.

The Ignis system should be stored in its transport case and under the following conditions:

- Temperatures such that the interior of the case will maintain a temperature range of -5°C to 50°C .

- Out of direct sunlight to prevent excessive temperatures.
- Humidity under 90% and non-condensing on the surface of Ignis.

Particular care should be taken when transporting the system to ensure that it is stored in a location that is not excessively hot (e.g. the interior of a truck left parked in hot sun) and that it is handled with a similar level of care to that of the drone.

1.13 Warranty

See sales agreement for details of the warranty.

2 Supporting Equipment

2.1 Camera

We highly recommend flying with a camera for greater situation awareness. You can connect a 3rd-party camera to the drone via HDMI or AV, but we recommend using a DJI Zenmuse camera due to the integrated gimbal and in-app control. There are several options to choose from among the Zenmuse cameras: the X3 is an affordable visible camera, and the XT2 is a combined visible and thermal camera. We make a custom mounting bracket for these cameras that allows you to attach Ignis under the center of the vehicle for a more balanced center of mass.

2.2 Laptop with DJI Assistant 2

We recommend bringing a laptop with DJI Assistant 2 installed, in case the drone's configuration is reset. This could happen if you update the drone's firmware, but forget to reconfigure the drone's pwm and api settings. There has also been one case in which the M600 spontaneously reset its settings and needed to be reconfigured in the field. The drone may also become "Locked" after a firmware update, and DJI Assistant 2 or the official DJI Go app can be used to unlock the drone.

2.3 Generator

If you want to do many flights with the Matrice 600, you'll need to recharge your batteries in the field, which will require a 3 kW generator. The DJI Hex Charger is able to charge a

full set of 6 flight batteries and up to two controllers simultaneously, but it can take about an hour and a half. If you have multiple chargers being powered by a generator, then you can start charging each set of batteries as you finish with them.

Num Chargers	Num Battery Sets	Down time	Power Required
1	2	65 min	1000 W
2	3	40 min	2000 W
3	4	15 min	3000 W
4	5	0 min	4000 W

Table 2: Operation capabilities and requirements for different numbers of chargers

Table 2.3 compares how much down time between periods flying you'll have for different numbers of chargers. On hot days, we recommend rotating in an extra set of batteries so that the batteries will have a chance to cool down before being put on the charger.

2.4 Tarp

If you are taking off or landing from a dusty area, it may be useful to stake down a large tarp over your landing zone to prevent the prop wash from kicking up dust.

2.5 Antenna Improvements

The Matrice 600 controller has a theoretical range of 5 km, but this is very dependent on maintaining a clear line between the controller and drone. If the signal has to pass through trees or other vegetation, then video quality will be degraded and range will be significantly reduced. We recommend repositioning to maintain a clear path for the signal. There are also 3rd-party controller modifications that boost the signal and allow you to position the controller's antennas on a pole, which may improve signal quality. We do not have any recommended modifications.

3 Normal Procedures

This section contains the normal procedure checklists. See the Amplified Normal Procedures in Section 4 for details.

3.1 Preflight Inspection Checklist

1. **Ignition, Flight Plan, and Emergency Procedures:** BRIEFED
2. **Environmental Conditions and Forecast:** WITHIN LIMITS
3. **Inspect for Visible Damage:** NO DAMAGE
4. **Hatches:** A AND B CLOSED
5. **Dropper Attached to Hopper:** SECURED
6. **Battery Install:** INSTALLED
7. **Hopper Attached to Drone:** SECURED
8. **Hopper Cable Connected to Drone:** CONNECTED
9. **Disarm Ignis:** DISARMED
10. **Emergency Release Dials:**
ROTATED COUNTERCLOCKWISE, SAFE
11. **DJI Mode Set to P or F:** FLIGHT MODE SET
12. **Battery Connect:** CONNECTED
WARNING: ensure that fingers and other items are clear of all moving parts.
13. **Verify Puncture Motion:** MOVING
14. **Start Ignis App:** OPEN
15. **Ignis App Ignis Setup:** CONNECTED
16. **Ignis Battery Level:** GREATER THAN 7.4V
17. **Injection Amount:** SET
18. **Reservoir and Pumps:** FILLED AND PURGED OF AIR
19. **Dropper Needle:** A AND B CLEAR AND INSTALLED
20. **Drone Preflight Inspection:** COMPLETED
21. **(OPTIONAL) Start Test Ignitions:** INJECTING AND DROPPING
WARNING: If ignition spheres are loaded in the hopper, this will cause them to be injected and poses a fire risk. If performing this step, do so under controlled conditions.
22. **Stop Dropping:** DISARMED, IGNIS STOPPED
23. **Check Ignis Status in App:** DISARMED BY CONTROL BAR
24. **Create Geofence:** CREATED
25. **Fill Hopper:** FILLED
Note: Use the app "AGITATE" button when filling to ensure chutes are filled
26. **Ready for Takeoff:** READY

3.2 Matrice 600 Pro Preflight Inspection Checklist

1. **Inspect Remote Controller for Visible Damage:** NONE
2. **Check Remote Controller Battery Charge Level:** AT LEAST TWO SOLID LIGHTS
3. **Check Tablet is Clamped Securely by the Remote Controller:** SECURE
4. **Connect USB cable from Remote Controller to Tablet:** CONNECTED
5. **Check Flight Mode Switch is set to P or F:** P OR F

Note: F mode allows for autonomous flight operations, such as following waypoints

6. **Check Tablet for Visible Damage:** NONE
7. **Check Tablet Battery Charge Level:** AT LEAST 25%
8. **Check Ignis Control Bar is plugged into Remote Controller:** CONNECTED
9. **Check 6 Flight Batteries for Visible Damage:** NO DAMAGE
10. **Check 6 Flight Batteries are of the Same Set:** SAME SET
11. **Check 6 Flight Batteries Charge Level:** AT LEAST THREE SOLID LIGHTS
12. **Check 6 Flight Batteries Charge Level Similarity:** SIMILAR

Note: No battery should be more than one blinking light different than any other

13. **Check Vehicle Camera for Visible Damage:** NO DAMAGE
14. **Check Vehicle Camera Configuration:** CORRECT
15. **Check Vehicle Camera Battery Charge Level:** AT LEAST 25%
16. **Check Vehicle Camera Securely Mounted to Vehicle:** SECURE
17. **Check Vehicle Camera Connection to Vehicle:** CONNECTED
18. **Carry Vehicle to Takeoff Point:** DONE
19. **Face Vehicle away from Piloting Position:** DONE
20. **Clear Takeoff Point of Obstacles in 10 foot Radius:** CLEAR
21. **Clear Takeoff Point of Bystanders in 20 foot Radius:** CLEAR
22. **Raise GPS:** DONE
23. **Raise and Lock Arms:** DONE
24. **Remove and Store Propeller Covers:** DONE
25. **Expand Propellers:** DONE
26. **Insert Batteries:** DONE
27. **Check Propellers for Damage:** NONE

Note: Run your fingers along the blades to feel for nicks, cracks, and flexing

28. **Check Arms are Locked:** LOCKED
29. **Check Arms for Visible Damage:** NONE
30. **Check 6 Flight Batteries are Fully Inserted:** SECURE
31. **Check GPS are Fully Raised:** RAISED

32. Check GPS Orientation: FORWARD

Note: the red arrow on top of the GPS should point towards the front of the vehicle

33. Check Body for Visible Damage: NONE**34. Check Landing Gear for Visible Damage: NONE****35. Check Landing Gear Clearance: CLEAR**

Note: Check for any dangling cables that could snag the landing gear and prevent it from raising or lowering

36. Start Flight App on Tablet: STARTED**37. Turn on Controller: ON****38. Select App for USB Connection: SELECTED**

Note: If this screen does not appear, disconnect and reconnect the USB cable. If another app automatically starts, you need to clear the Open by default settings for that app.

39. Verify Connection to Controller in App: CONNECTED**40. Turn on Vehicle Camera: ON****41. Turn on Vehicle and Move Back: ON****42. Verify Connection to Vehicle in App: CONNECTED****43. Check App for Radio Uplink Signal Strength: AT LEAST 4 BARS****44. Check App for Video Downlink Signal Strength: AT LEAST 4 BARS****45. Check App for Vehicle Battery Level: AT LEAST 60%****46. Check App for GPS Signal: AT LEAST 4 BARS AND 9 SATELLITES**

Note: It may take a while to acquire GPS Lock

47. Check App for Other Errors: NONE**48. Verify Camera Feed to App: STREAMING**

3.3 Starting Dropping and Ignitions Checklist

1. Arm Ignis: ARMED**2. Check Ignis Status: IDLE****3. Ensure Drop Area Clear and Safe: CLEAR AND SAFE****4. Press Start Dropping button in App: PRESSED****5. Check Ignis Status: DROPPING**

3.4 Stopping Ignitions Checklist

1. **Press Stop Dropping button in App:** PRESSED
2. **Check Ignis Status:** IDLE
3. **Disarm Ignis:** DISARMED

3.5 Reloading Between Flights Checklist

1. **Disarm Ignis:** DISARMED
2. **Emergency Release Dials:**
ROTATED COUNTERCLOCKWISE, SAFE
3. **Ignis App Ignis Setup:** CONNECTED
4. **Ignis Battery Level:** GREATER THAN 7.4V
5. **Reservoir and Pumps:** FILLED AND PURGED OF AIR
6. **Drone Preflight Inspection:** COMPLETED
7. **(OPTIONAL) Start Test Ignitions:** INJECTING AND DROPPING
WARNING: If ignition spheres are loaded in the hopper, this will cause them to be injected and poses a fire risk. If performing this step, do so under controlled conditions.
8. **Stop Dropping:** DISARMED, IGNIS STOPPED
9. **Fill Hopper:** FILLED
Note: Use the app "AGITATE" button when filling to ensure chutes are filled
10. **Ready for Takeoff:** READY

3.6 Post Flight Inspection Checklist

1. **Drone Safe:** SAFE
2. **Slipper Block:** EMPTY
3. **Ignis Battery:** DISCONNECTED
4. **Inspect for Visible Damage:** NO DAMAGE

3.7 Preparing for Storage Checklist

1. **Remove Needles from Dropper and Store:** COMPLETE
2. **Separate Dropper from Hopper:** COMPLETE
3. **Clean System:** CLEAN
4. **Empty Reservoir and Pumps:** EMPTY
5. **Flush With Water:** FLUSHED AND EMPTIED
6. **Disconnect Battery:** DISCONNECTED
7. **Remove Battery:** REMOVED
8. **Inspect for Visible Damage:** NO DAMAGE
9. **Store in Case:** STORED

4 Amplified Normal Procedures

4.1 Preflight Inspection Checklist

4.1.1 Ignition, Flight Plan, and Emergency Procedures

Ignition, Flight Plan, and Emergency Procedures: BRIEFED

Ensure that all personnel that are both directly and indirectly involved in the flight and ignition operations are briefed on the drone ignition and flight plan. In addition, all personnel must be briefed on safety procedures and emergency procedures.

The PIC is also responsible for ensuring that all regulatory requirements are met, including, but not limited to, filling a flight plan as needed, ensuring that personnel are clear of the operating area, ensuring no unintended property will be damaged by ignitions, filling ignition plans as needed, etc.

4.1.2 Environmental Conditions and Forecast

Environmental Conditions and Forecast: WITHIN LIMITS

Ensure that the weather and the forecasted conditions are within limits for both the Ignis system and the drone. See 1.9 for detailed specifications.

In addition, storage in hot conditions or leaving the system exposed to direct sunlight may cause the system to exceed its operational temperature even if the air temperature is within limits.

4.1.3 Inspect for Visible Damage

Inspect for Visible Damage: NO DAMAGE

Perform a visual inspection to ensure that there is no damage to the system and that all cables, connectors, and screws are secure and clean. In particular, check:

- The magnets on the extended cylinders on the slipper block protrude slightly from the aluminum cylinders and are clean and undamaged (see Figure 10).
- The needle assemblies were not damaged in storage or transport.

Do not fly it with any worn or damaged parts.

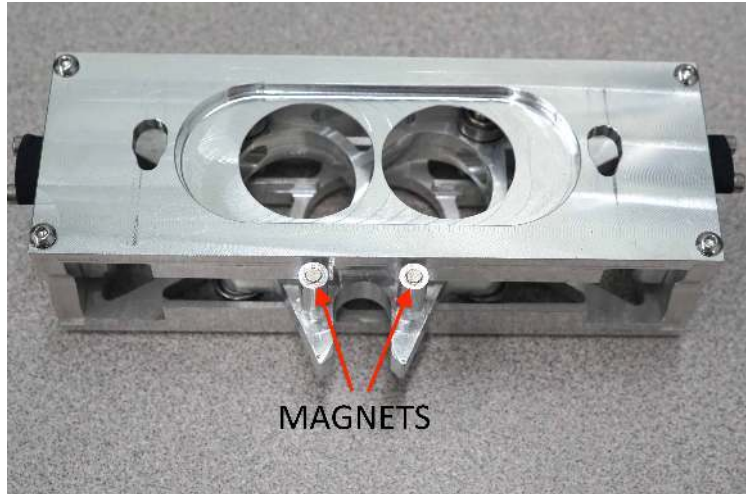

Figure 10: Magnets on extended cylinders on slipper block must protrude slightly, be clean and undamaged.

4.1.4 Hatches

Hatches: A AND B CLOSED

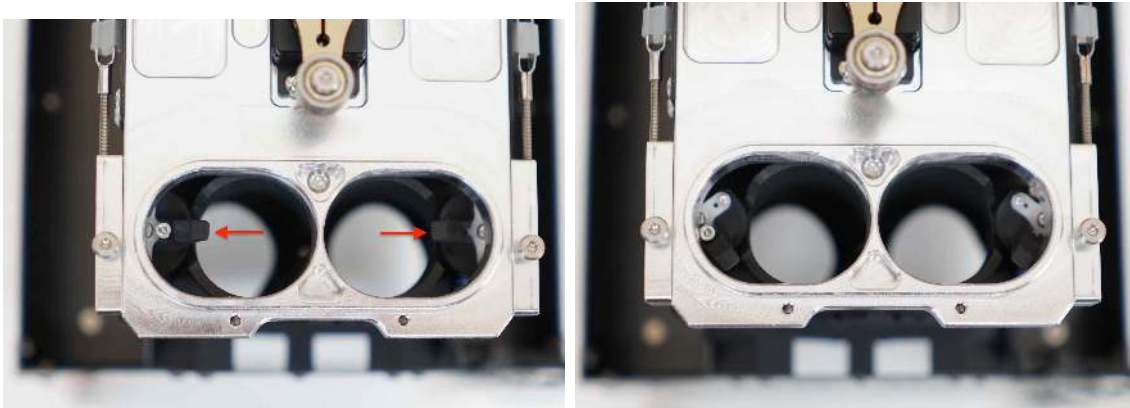

Figure 11: Left: Hatches closed, blocking spheres from feeding into dropper. Right: Hatches open

Ensure that the hatches are in the closed position as shown in Figure 11. If they are not, the hatches can be moved by hand with minimal force.

4.1.5 Dropper Attached to Hopper

Dropper Attached to Hopper: SECURED



Figure 12: Attaching the Dropper to the Hopper.

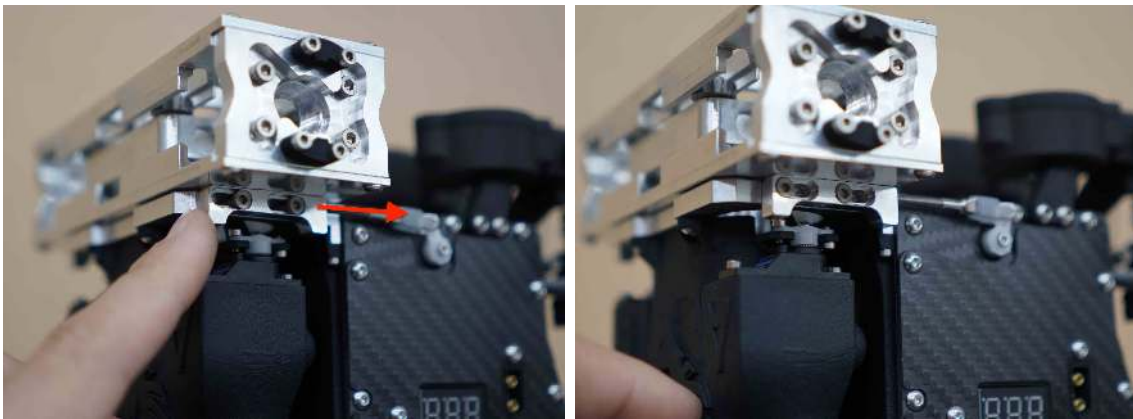

Figure 13: To lock the Dropper in place, push the emergency release lock on each side of the dropper back.

Figure 12 shows the process for attaching the Dropper to the Hopper. Start by aligning the drive bearings with the opening in the slipper block Figure 12(left). Then align the shoulder screw on the emergency release lock with the teardrop-shaped cutout on the dropper top plate as shown in Figure 12(right). Then manually secure the dropper by pushing the emergency release locks back towards the pumps as shown in Figure 13.

4.1.6 Battery Install

Battery Install: INSTALLED

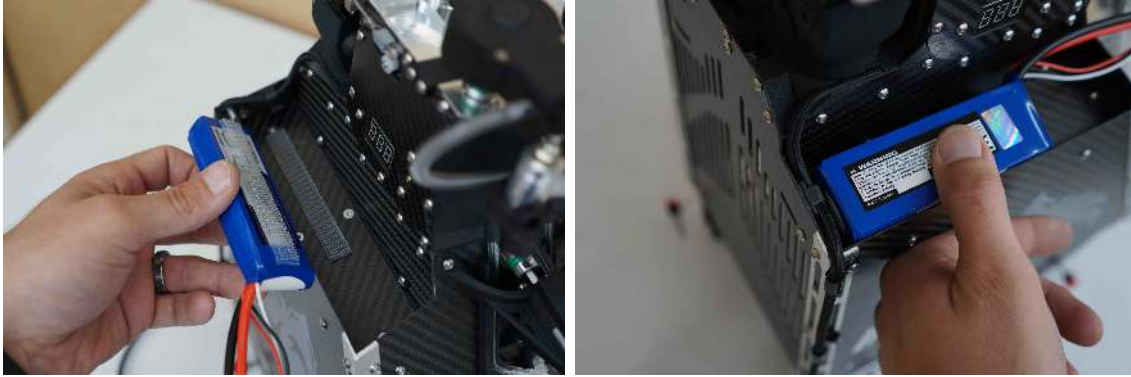

Figure 14: Left: Battery install location. Right: Locate battery all the way forward and to the outside edge. Press to engage fastener.

Figure 14 shows the process for installing the battery. Start by opening and aligning the battery as close to the front and outside edge as possible. Press firmly until the fastener engages which usually makes an audible and tactile click. Sometimes, a side-to-side rocking motion while pressing helps engage the fastener.

4.1.7 Hopper Attached to Drone

Hopper Attached to Drone: SECURED

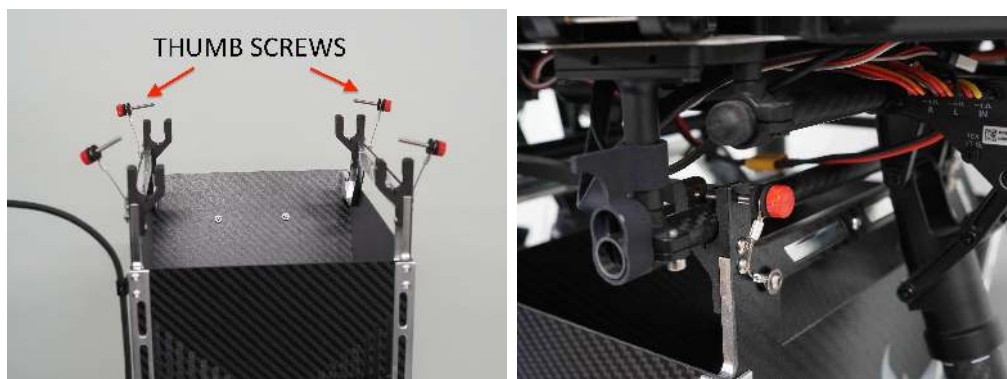

Figure 15: Attaching hopper to Drone. Left: Remove thumb screws. Right: Attach to drone.

Figure 15 shows the process for attaching the Hopper to the drone. Start by removing the red thumb screws from the top of the Hopper as shown in Figure 15(left). Snap the Hopper onto the rails of the drone, as shown in Figure 15(right), and slide it along the rails to ensure that the Hopper is aligned with the center mass of the drone. Finally, reinstall and lightly tighten the red thumb screws to secure the Hopper to the drone.

Note that the Hopper should be oriented such that the reservoir is towards the back of the drone.

4.1.8 Hopper Cable Connected to Drone

Hopper Cable Connected to Drone: CONNECTED



Figure 16: Attaching cable from the Hopper to the Drone.

Attach the cable between the Hopper and the drone as shown in Figure 16.

4.1.9 Disarm Ignis

Disarm Ignis: DISARMED



Figure 17: Ignis control switches.

Ensure the Ignis Arm/Disarm switch (S3) is pushed down and away from the user to disable dropping with Ignis.

4.1.10 Emergency Release Dials

Emergency Release Dials:

ROTATED COUNTERCLOCKWISE, SAFE

Ensure that the emergency release dials (S1 and S2) shown in Figure 17 are rotated fully counterclockwise. Rotating both dials fully clockwise within 2 seconds of each other will trigger the emergency release. We recommend regularly testing that the emergency release works properly while on the ground, see Section 6.2.

4.1.11 DJI Mode Set to P or F

DJI Mode Set to P or F: FLIGHT MODE SET

The DJI flight mode selection switch must be set to P or F for operation of the Ignis System.

4.1.12 Battery Connect

Battery Connect: CONNECTED

WARNING: ensure that fingers and other items are clear of all moving parts.

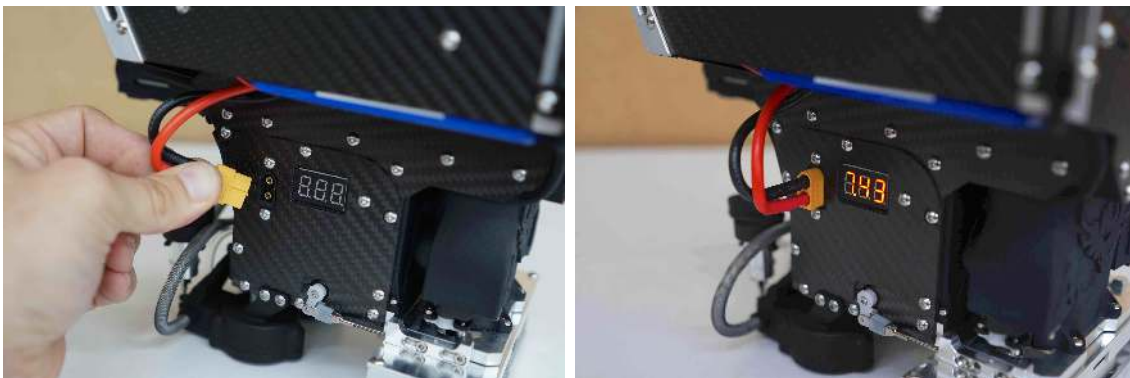

Figure 18: Connecting the battery.

Figure 18 shows where to connect the battery. This will immediately power on the system. Ensure that all fingers and other items are clear of all moving parts. The battery voltage will be displayed as soon as the system is powered.

4.1.13 Verify Puncture Motion

Verify Puncture Motion: MOVING

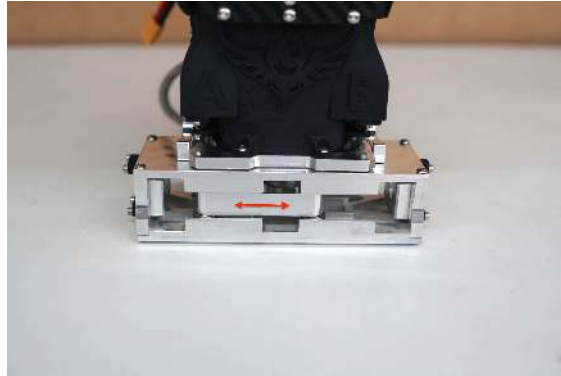

Figure 19: Puncture actuator location.

Once power is applied, the puncture actuator, shown in Figure 19, should travel back and forth as the calibration procedure is performed. Verify that it moves smoothly along the full length.

4.1.14 Start Ignis App

Start Ignis App: OPEN

Open the Ignis app on your tablet or phone. On start the app will show a main menu as shown in Figure 20.



Figure 20: Main Menu of Ignis app.

4.1.15 Ignis App Ignis Setup

Ignis App Ignis Setup: CONNECTED

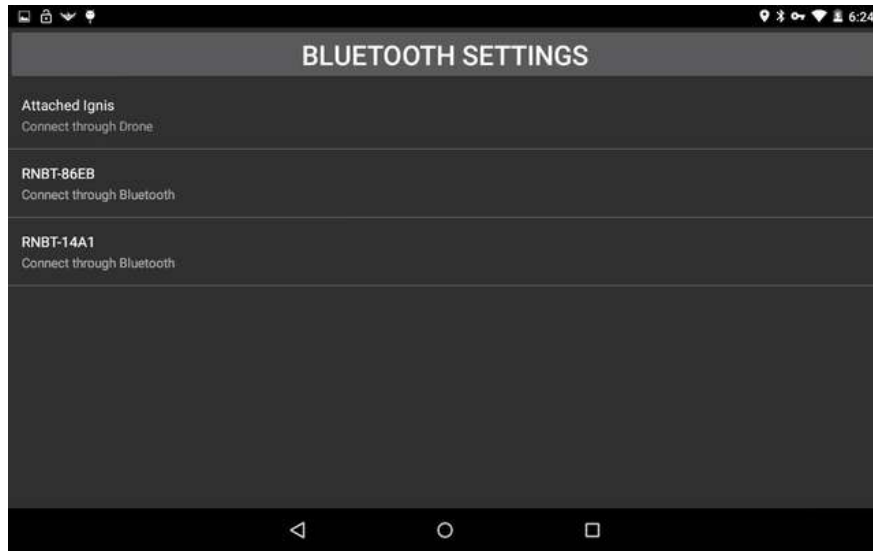

Figure 21: Ignis Setup Menu for choosing how to connect to Ignis.

Press the IGNIS SETUP button to see the connection options screen as shown in Figure 21. On this screen you will see a list of all the Bluetooth devices your tablet is paired to. You can touch one of these to connect to that Ignis via Bluetooth. Alternatively, if the controller and drone are on and there is a connection from the app to Ignis through the drone, you will see an option to connect to Ignis through the drone. If your tablet is not paired to the Ignis's Bluetooth, you can press the BLUETOOTH SETTINGS button to open up your Android device's Bluetooth settings. This will scan for nearby Bluetooth devices and allow you to pair with them. The password to pair with Ignis is 1234.

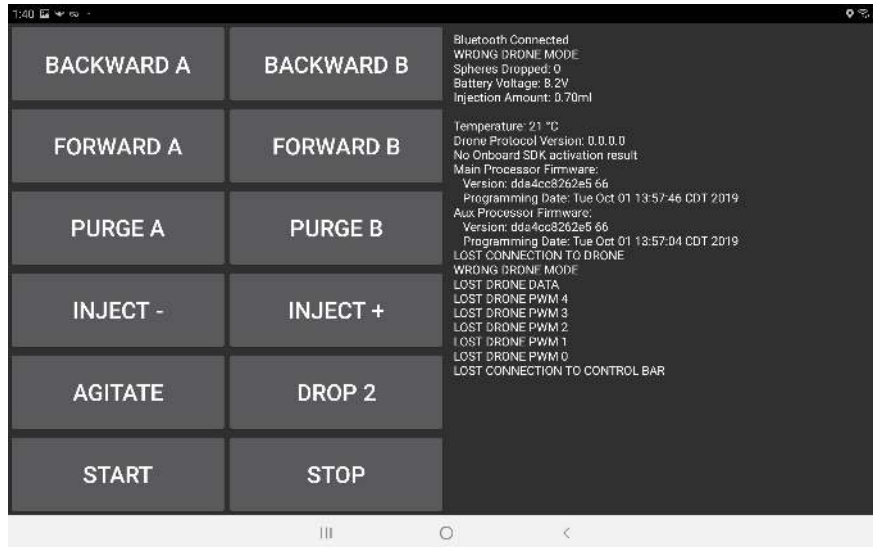

Figure 22: App when connected to Ignis.

Touch the connection option corresponding to the Ignis’s Bluetooth Address, which is shown inside the battery compartment, to begin connecting to Ignis over Bluetooth. This will open a screen similar to Figure 22. The status will initially show “Bluetooth Disconnected” while the app is attempting to connect. Once it successfully connects, which may take up to 10 seconds, the status will change to “Bluetooth Connected”. Ignis’s status will be displayed once the app begins to receive messages from Ignis.

4.1.16 Ignis Battery Level

Ignis Battery Level: GREATER THAN 7.4V

Verify that the battery voltage is above 7.4V in the app (Figure 22). See Section 1.3 for more information about the battery and power information.

4.1.17 Injection Amount

Injection Amount: SET

Use the “INJECT +” and “INJECT -” buttons to set the injection amount in milliliters (ml), the default setting of 0.4 mL works under most conditions. Verify that the status message indicates that the injection amount has been set as shown in Figure 22. See Section 1.10 for additional details.

4.1.18 Reservoir and Pumps

Reservoir and Pumps: FILLED AND PURGED OF AIR

Figure 23 shows how to prime the hand pump on the antifreeze jug by grasping the jug handle and pump with one hand while rotating the handle rapidly clockwise with the other hand until antifreeze passes from the jug through the tube leading into the pump and out the tube on the output side of the pump (marked in red). There will be a significant increase in resistance to turning when the antifreeze enters the pump. Once this resistance is felt, stop turning the handle.



Figure 23: Prime pump by cranking rapidly clockwise until antifreeze enters pump

To fill the reservoir, grasp the fill coupler, placing thumb in the depression on top and splitting forefinger and middle finger with the protrusion on the back as shown in Figure 24.



Figure 24: Proper grip on fill coupler

Connect the coupler to the reservoir as shown in Figure 25.



Figure 25: Left: Align the tubes on the coupler with the check valve barbs. Right: Press the coupler onto the reservoir until it stops.

Crank the hand pump clockwise just like when priming until the reservoir is completely full. When the antifreeze reaches the top of the reservoir, it will return to the jug via the vent line, so there is no way to overfill the reservoir.

Remove the fill coupler and store on the antifreeze jug as shown in Figure 26. Note that the pump does not form a complete seal when at rest, so if the antifreeze jug is overturned in storage or during transit, it will leak. We recommend replacing the factory original cap on the jug or firmly securing the jug upright for storage and transport.



Figure 26: Store the coupler on the antifreeze jug between uses to prevent contamination from dirt and to prevent siphoning.

To purge the air out of the tubing between the reservoir and needles, hold the button in the center of the status LED (Figure 27) below the reservoir for 3 seconds.



Figure 27: The status LED with multi-function button is located below the reservoir.

This will run both pumps forward for approximately 3 seconds to draw fluid from the reservoir towards the needles. This process may need to be repeated several times until antifreeze has reached both needles.

4.1.19 Dropper Needle

Dropper Needle: A AND B CLEAR AND INSTALLED

Before each flight the needle should be removed and it should be verified that it is clear of any foreign material and that it is sharp.

This process is identical for the Dropper A needle and the Dropper B needle.

To remove the needle assembly, push in on the black knob labeled “IGNIS” on the needle assembly, twist it counter-clockwise until it stops, and pull it out.

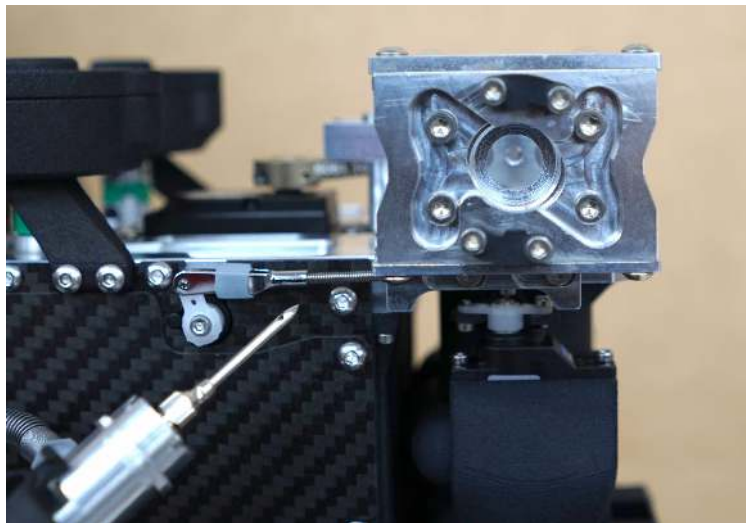

Figure 28: Location to insert the needle.

To insert the needle assembly, slide the needle into the hole in Figure 28. You may need to rotate the needle assembly in order to fully insert the needle.

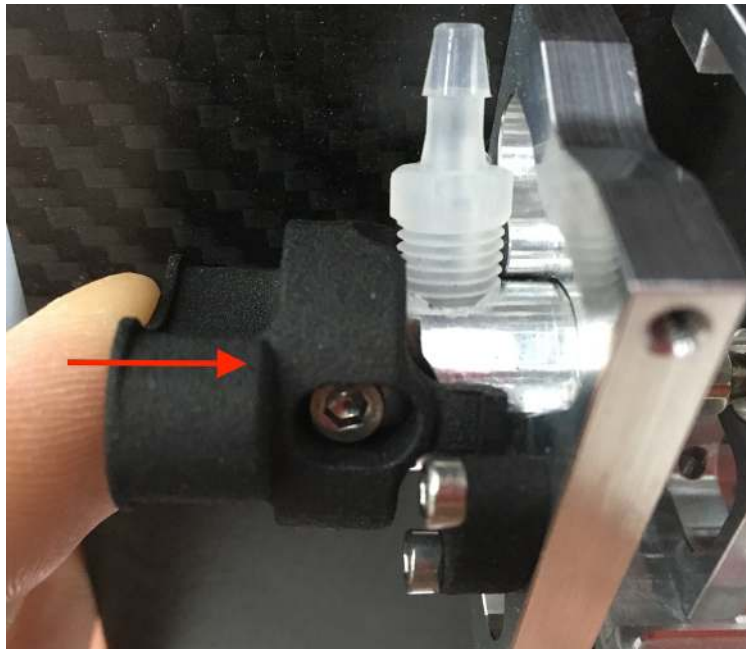

Figure 29: Locking the needle assembly.

To lock the needle assembly in place, push inward on the black knob labeled “IGNIS” (as shown in Figure 29), and twist the knob clockwise until it stops, then pull back on the knob to click it in place. Verify the needle assembly is locked by attempting to twist the knob counter-clockwise. It should not be able to rotate.

4.1.20 Drone Preflight Inspection

Drone Preflight Inspection: COMPLETED

Ensure that the drone’s preflight inspection is complete.

See section 3.2 for the Matrice 600 Pro preflight inspection checklist.

4.1.21 (OPTIONAL) Start Test Ignitions

(OPTIONAL) Start Test Ignitions: INJECTING AND DROPPING

WARNING: If ignition spheres are loaded in the hopper, this will cause them to be injected and poses a fire risk. If performing this step, do so under controlled conditions.

This can be performed with or without ignition spheres. However, if ignition spheres are loaded, care must be taken as this will cause the ignition spheres to ignite, which poses a

significant **fire risk**. In addition, the ignition spheres can “jump” a significant amount when igniting, so make sure a significant area is clear if performing live ignitions.

If you do not want to ignite ignition spheres, we recommend removing the needles for this test to make sure that the ignition spheres cannot be injected.

Start continuous drops by first moving S3 on the control bar into the upward position to arm Ignis. Then press the Start button in the Drone Amplified Android app.

During this process, verify the following:

- The puncture motor moves (see Section 4.1.13).
- The A and B hatches open without obstruction.
- Ignition spheres are loaded and punctured in both A and B (if performed with ignition spheres).
- Fluid is injected in both A and B.
- The app status indicates dropping.

This process will perform injections on both A and B sides until stopped.

4.1.22 Stop Dropping

Stop Dropping: DISARMED, IGNIS STOPPED

Press the Stop button in the app to stop dropping. To also disarm Ignis in order to prevent accidentally starting again, move the Arm/Disarm switch (S3) on the control bar into the disarm position (down and away from the user), as shown in Figure 4. Further, make sure that all motions of the system stop and that the app indicates ready. Note that the stopping process can take 5-10 seconds while the system purges any additional ignition spheres and performs a calibration process.

4.1.23 Check Ignis Status in App

Check Ignis Status in App: DISARMED BY CONTROL BAR

Verify that the status message in the app’s flying screen indicates Ignis has no errors.

4.1.24 Create Geofence

Create Geofence: CREATED



Figure 30: Creating a geofence for Ignis in the Ignis app.

Touch the ignition sphere icon in the top right corner of the flight screen to open the Ignis controls, then touch the Geofence icon (the boxed drone icon) to open the Geofence controls (see Figure 30). Touch the map to mark the corners of the burn area in a clockwise or counter-clockwise order. You can also undo, redo, or clear the geofence.

Once you've finished creating the geofence, touch the ignition sphere icon in the top right corner to close the Ignis controls.

4.1.25 Fill Hopper

Fill Hopper: FILLED

Note: Use the app "AGITATE" button when filling to ensure chutes are filled



Figure 31: Left: Filling the Hopper with ignition spheres. Right: Approximate capacities.

Fill the Hopper with the desired number of ignition spheres as shown in Figure 31. Filling the Hopper to the bottom of the aluminum brackets is approximately 400 ignition spheres. It

is recommended to only fly with 400 spheres but it is possible to fit 450 spheres by filling the Hopper to the top of the carbon fiber sides. With this many spheres, the injection amount cannot be set above 0.4 mL or the reservoir will run dry before dropping all 450 spheres.

It is important to make sure that the chutes at the bottom of the Hopper are filled with ignition spheres so that the first injections are not missed due to the lack of spheres. During the filling process, use the “AGITATE” button on the app to briefly move the agitator in the hopper with just a few initial spheres, as shown in Figure 22. Once the chutes are full, the remaining ignition spheres can be quickly added.

4.1.26 Ready for Takeoff

Ready for Takeoff: READY

Ignis is now ready for flight operations. Ensure that the area is clear and abide by all flight and takeoff recommendations of the drone manufacturer.

4.2 Starting Dropping and Ignitions Checklist

4.2.1 Arm Ignis

Arm Ignis: ARMED

Move S3 on the control bar into the armed position (up and towards the user).

4.2.2 Check Ignis Status

Check Ignis Status: IDLE

Check that Ignis’s status indicates it is idle, or a restartable error (see Section 1.8).

4.2.3 Ensure Drop Area Clear and Safe

Ensure Drop Area Clear and Safe: CLEAR AND SAFE

Ensure that the drone is currently over a safe area to perform ignitions and that the area is clear.

4.2.4 Press Start Dropping button in App

Press Start Dropping button in App: PRESSED

Press the Start button in the Drone Amplified Android app to start dropping.

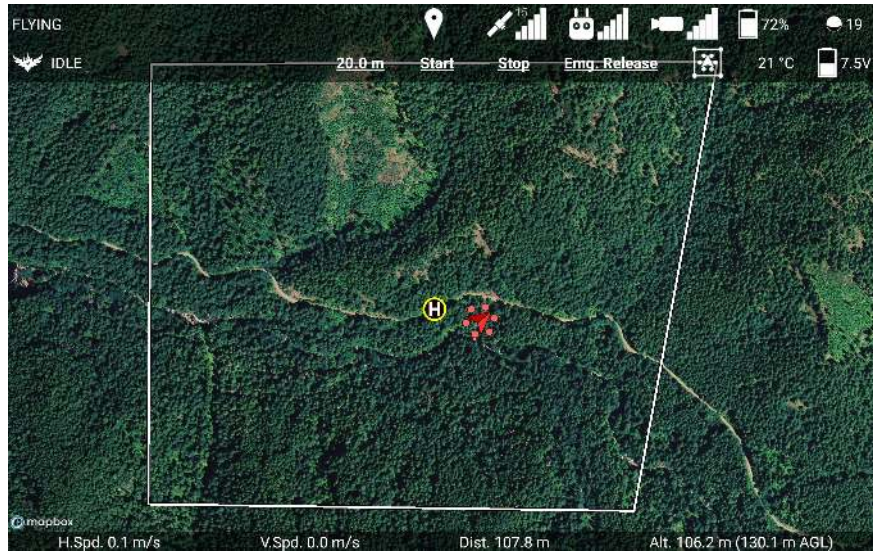

Figure 32: Starting drops with the Drone Amplified Android app.

The Start dropping button is located in the Ignis controls submenu, shown in Figure 32. This submenu will appear when the ignition sphere icon in the top-right corner is touched.

This process will start drops alternating between the A and B sides. The total number of continuous drops is capped at approximately 500 spheres, which is above the capacity of Hopper. However, if this number is exceeded, it will stop dropping. It can be reinitialized by stopping and starting the dropping again.

4.2.5 Check Ignis Status

Check Ignis Status: DROPPING



Figure 33: Ignis status while dropping.

Verify that Ignis's status has changed to DROPPING, as in Figure 33.

4.3 Stopping Ignitions Checklist

4.3.1 Press Stop Dropping button in App

Press Stop Dropping button in App: PRESSED

Press the Stop button in the Drone Amplified Android app to stop dropping. This will safely stop dropping at any point, although additional ignition spheres may be dispensed as they are cleared from the chutes.

The Stop dropping button is located in the Ignis controls submenu, shown in Figure 33. This submenu will appear when the ignition sphere icon in the top-right corner is touched.

4.3.2 Check Ignis Status

Check Ignis Status: IDLE

Verify that Ignis's status has changed to IDLE, as in Figure 32. Note that the stopping process can take 5-10 seconds while the system purges any additional ignition spheres and performs a calibration process.

4.3.3 Disarm Ignis

Disarm Ignis: DISARMED

Move S3 on the control bar into the disarmed position (down and away from the user).

4.4 Reloading Between Flights Checklist

4.4.1 Disarm Ignis

Disarm Ignis: DISARMED



Figure 34: Ignis control switches.

Ensure the Ignis Arm/Disarm switch (S3) is pushed down and away from the user to disable dropping with Ignis.

4.4.2 Emergency Release Dials

Emergency Release Dials:

ROTATED COUNTERCLOCKWISE, SAFE

Ensure that the emergency release dials (S1 and S2) shown in Figure 34 are rotated fully counterclockwise. Rotating both dials fully clockwise within 2 seconds of each other will trigger the emergency release.

4.4.3 Ignis App Ignis Setup

Ignis App Ignis Setup: CONNECTED

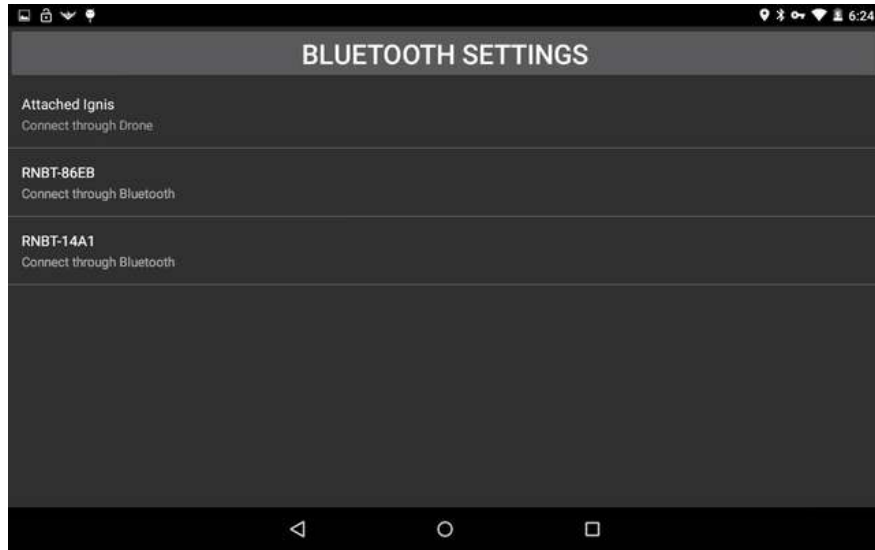

Figure 35: Ignis Setup Menu for choosing how to connect to Ignis.

Press the IGNIS SETUP button to see the connection options screen as shown in Figure 35. On this screen you will see a list of all the Bluetooth devices your tablet is paired to. You can touch one of these to connect to that Ignis via Bluetooth. Alternatively, if the controller and drone are on and there is a connection from the app to Ignis through the drone, you will see an option to connect to Ignis through the drone. If your tablet is not paired to the Ignis’s Bluetooth, you can press the BLUETOOTH SETTINGS button to open up your Android device’s Bluetooth settings. This will scan for nearby Bluetooth devices and allow you to pair with them. The password to pair with Ignis is 1234.

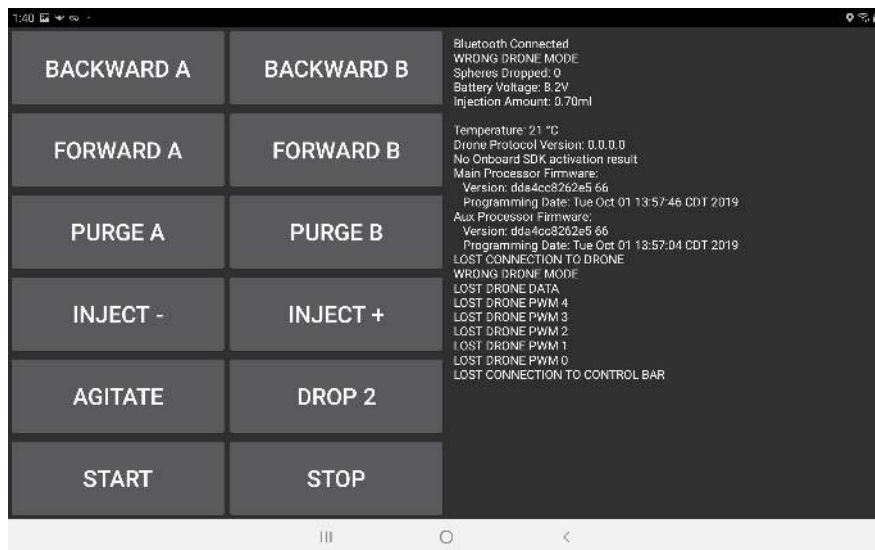

Figure 36: App when connected to Ignis.

Touch the connection option corresponding to the Ignis's Bluetooth Address, which is shown inside the battery compartment, to begin connecting to Ignis over Bluetooth. This will open a screen similar to Figure 36. The status will initially show "Bluetooth Disconnected" while the app is attempting to connect. Once it successfully connects, which may take up to 10 seconds, the status will change to "Bluetooth Connected". Ignis's status will be displayed once the app begins to receive messages from Ignis.

4.4.4 Ignis Battery Level

Ignis Battery Level: GREATER THAN 7.4V

Verify that the battery voltage is above 7.4V in the app (Figure 22). See Section 1.3 for more information about the battery and power information. If

4.4.5 Reservoir and Pumps

Reservoir and Pumps: FILLED AND PURGED OF AIR



Figure 37: Refilling reservoir

Fill the reservoir by connecting the fill coupler and cranking the hand pump (see Figure 37).

If the reservoir was emptied during the last flight, you may need to purge air from the pumps and tubing. Press and hold the button in the center of the status LED below the syringe for 3 seconds, then release the button and the pumps will run forward for 3 seconds. Repeat this procedure until antifreeze fills the tubes and reaches the needles.

4.4.6 Drone Preflight Inspection

Drone Preflight Inspection: COMPLETED

Ensure that the drone's preflight inspection is complete.

See section 3.2 for the Matrice 600 Pro preflight inspection checklist.

4.4.7 (OPTIONAL) Start Test Ignitions

(OPTIONAL) Start Test Ignitions: INJECTING AND DROPPING

WARNING: If ignition spheres are loaded in the hopper, this will cause them to be injected and poses a fire risk. If performing this step, do so under controlled conditions.

This can be performed with or without ignition spheres. However, if ignition spheres are loaded, care must be taken as this will cause the ignition spheres to ignite, which poses a significant **fire risk**. In addition, the ignition spheres can “jump” a significant amount when igniting, so make sure a significant area is clear if performing live ignitions.

If you do not want to ignite ignition spheres, we recommend removing the needles for this test to make sure that the ignition spheres cannot be injected.

Start continuous drops by first moving S3 on the control bar into the upward position to arm Ignis. Then press the Start button in the Drone Amplified Android app.

During this process, verify the following:

- The puncture motor moves (see Section 4.1.13).
- The A and B hatches open without obstruction.
- Ignition spheres are loaded and punctured in both A and B (if performed with ignition spheres).
- Fluid is injected in both A and B.
- The app status indicates dropping.

This process will perform injections on both A and B sides until stopped.

4.4.8 Stop Dropping

Stop Dropping: DISARMED, IGNIS STOPPED

Press the Stop button in the app to stop dropping. To also disarm Ignis in order to prevent accidentally starting again, move the Arm/Disarm switch (S3) on the control bar into the disarm position (down and away from the user), as shown in Figure 4. Further, make sure that all motions of the system stop and that the app indicates ready. Note that the stopping process can take 5-10 seconds while the system purges any additional ignition spheres and performs a calibration process.

4.4.9 Fill Hopper

Fill Hopper: FILLED

Note: Use the app “AGITATE” button when filling to ensure chutes are filled



Figure 38: Filling the Hopper with ignition spheres.

Fill the Hopper with the desired number of ignition spheres as shown in Figure 38. Filling the Hopper to the bottom of the aluminum brackets is approximately 400 ignition spheres. It is recommended to only fly with 400 spheres but it is possible to fit 450 spheres by filling the Hopper to the top of the carbon fiber sides. With this many spheres, the injection amount cannot be set above 0.4 mL or the reservoir will run dry before dropping all 450 spheres.

It is important to make sure that the chutes at the bottom of the Hopper are filled with ignition spheres so that the first injections are not missed due to the lack of spheres. During the filling process, use the “AGITATE” button on the app to briefly move the agitator in the hopper with just a few initial spheres, as shown in Figure 36. Once the chutes are full, the remaining ignition spheres can be quickly added.

4.4.10 Ready for Takeoff

Ready for Takeoff: READY

Ignis is now ready for flight operations. Ensure that the area is clear and abide by all flight and takeoff recommendations of the drone manufacturer.

4.5 Post Flight Inspection Checklist

4.5.1 Drone Safe

Drone Safe: SAFE

Ensure that the drone is safe before approaching as specified in the drone operational manual. We recommend turning off the power to the drone before inspecting the Ignis system and following all drone manufacturer guidelines on approaching the drone after landing.

4.5.2 Slipper Block

Slipper Block: EMPTY

Ensure that the slipper block and dropper are empty. If there is a ignition sphere in this area, see the Emergency Procedures Section 6.3, for the clearing procedure.

4.5.3 Ignis Battery

Ignis Battery: DISCONNECTED

Disconnect the Ignis battery. It can take up to 30 seconds to completely power down after disconnecting battery.

4.5.4 Inspect for Visible Damage

Inspect for Visible Damage: NO DAMAGE

See Section 4.1.3

4.6 Preparing for Storage Checklist

4.6.1 Remove Needles from Dropper and Store

Remove Needles from Dropper and Store: COMPLETE

Remove the needle assemblies by pressing in, rotating a quarter turn counterclockwise and pulling out. Check the needles to make sure they are clear and nothing is plugging the outlet at their tips. The needles store on the back of the pumps as shown in Figure 39. The configuration on the right shows the proper arrangement for Ignis to fit in the travel case.

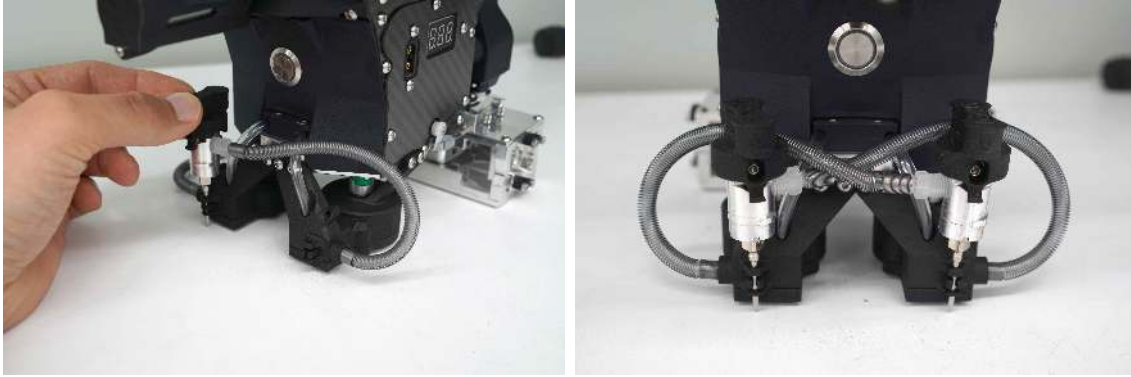

Figure 39: The needles store on the back sides of the pumps. Cross each needle to the opposite side pump to ensure Ignis fits in the storage case properly.

4.6.2 Separate Dropper from Hopper

Separate Dropper from Hopper: COMPLETE

If Ignis is powered on, perform an emergency release by rotating both dials fully clockwise within 2 seconds of each other to trigger the emergency release as shown in Figure 34. Or, use the Emg. Release button in the App to trigger an emergency release.

If Ignis is not powered and it has been at least 30 seconds since the battery was unplugged, manually unlock the emergency release brackets by sliding them forward as shown in Figure 40.

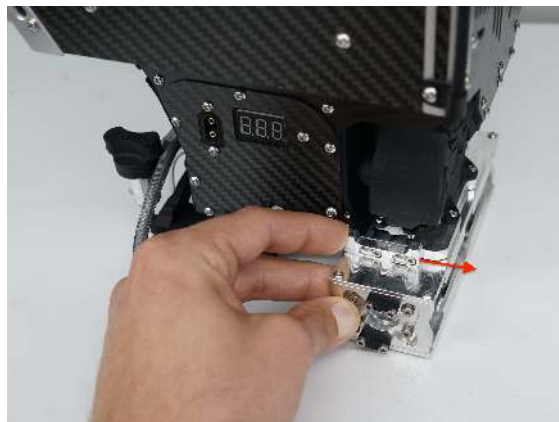

Figure 40: Manually separate the Dropper by sliding the emergency release bracket on both sides of the dropper forward

4.6.3 Clean System

Clean System: CLEAN

Wipe down the whole system with a clean, dry, and lint free cloth. Pay particularly close attention to remove any antifreeze buildup from the underside of the Hopper.

Apply a small amount of the dry lubricant to the brush and cotton swabs to clean the Dropper wherever dirty, paying special attention to the bearings on the slipper block and tracks they run on. Additionally, clean the oval cutout on top of the dropper where the Hopper and Dropper mate shown in Figure 41.

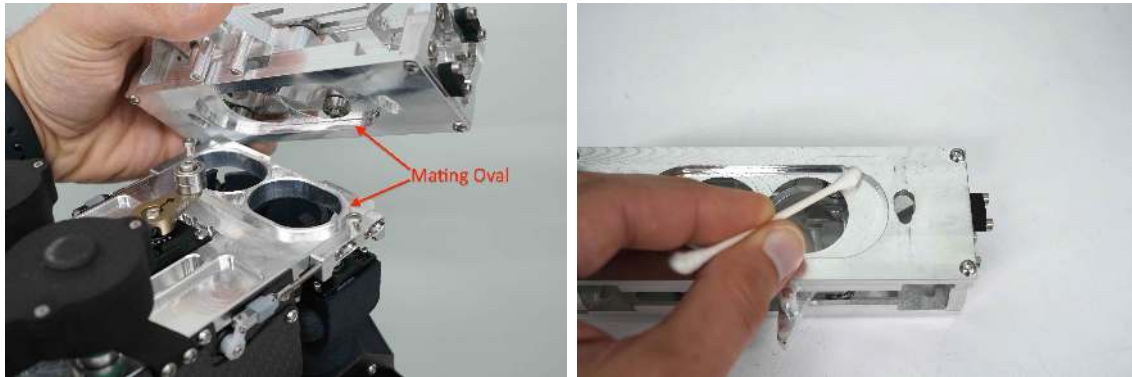

Figure 41: Clean the oval cutout where the Hopper and Dropper mate.

Build up of antifreeze or ash here could cause the Dropper to stick to the Hopper and not emergency release properly when triggered, allowing an in-flight fire to propagate to the rest of the drone.

If Dropper cannot be cleaned in the field before placing it back in the case, put the Dropper in the included plastic bag to help keep the rest of the case contents clean.

4.6.4 Empty Reservoir and Pumps

Empty Reservoir and Pumps: EMPTY

Turn Ignis upside down as shown in Figure 42. Plug in the battery and keep fingers clear of all moving parts while Ignis initializes. While waiting for Ignis to boot up, grasp the fill coupler on the antifreeze jug as before by placing thumb in the depression on top and splitting forefinger and middle finger with the protrusion on the back. Connect the fill coupler to the reservoir on Ignis.

Next, press and hold the button in the center of the status LED (which might be blinking red) for 3 seconds. Ignis has a sensor that allows it to detect whether it is upright or upside down. When upright, holding the button purges air out of the pumps by running them forward. When upside down, holding the button runs the pumps backwards to empty all the antifreeze back into the reservoir.

Once all the antifreeze has been pumped out of the tubing back into the reservoir, turn the hand pump on the antifreeze jug counterclockwise to drain the antifreeze in the reservoir back into the antifreeze jug. If cranking the hand pump counterclockwise does not start drawing from the reservoir, first check to make sure the coupler was attached to the reservoir in the correct orientation and then press and hold the LED button to start running the pumps backwards again. While the pumps are running, turn the hand pump counterclockwise rapidly. The pumps will create some back-pressure in the reservoir which helps push antifreeze to the hand pump to get it primed.

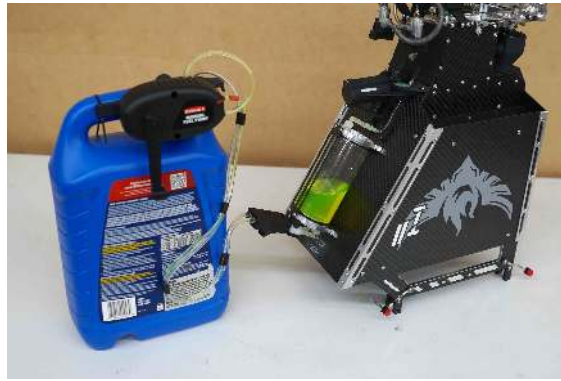

Figure 42: Turn Ignis upside down and connect the fill coupler to prepare to empty the reservoir, pumps and tubing

4.6.5 Flush With Water

Flush With Water: FLUSHED AND EMPTIED

With Ignis still upside down, fill the included syringe with “Y” fitting with water and connect the two short tubes from the “Y” fitting to the needles (see Figure 43). Once again, hold the button on the back of Ignis to run the pumps backwards. This will draw water from the syringe through the tubing and pumps and push it into the reservoir.

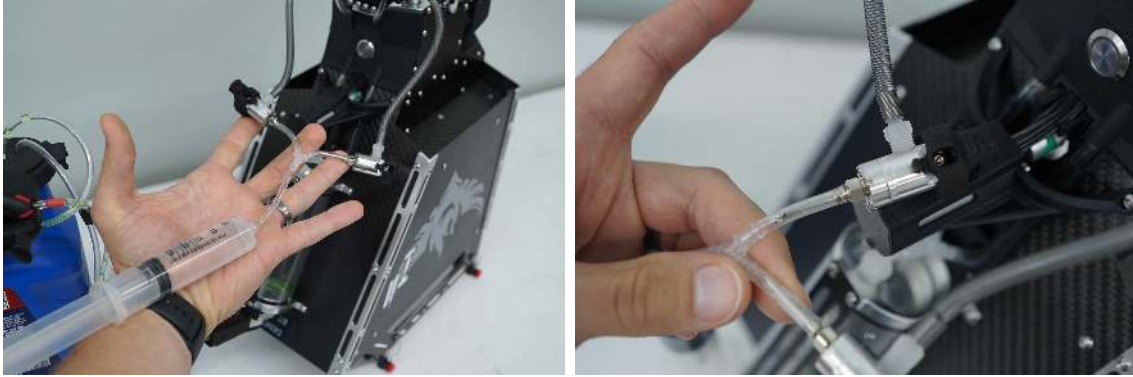

Figure 43: Connect the two tubes from the syringe to the needles to flush the pumps. The tube should slip over the base of the needle as shown (right).

This may need to be repeated a few times until the water runs clear. Once the water coming from the pumps into the reservoir, disconnect the needles from the syringe and store them properly.

Finally, flush out the check valves on the reservoir by taking the syringe filled with approximately 10 mL of water and connecting it to the check valves as shown in Figure 44.



Figure 44: Connect the two tubes from the syringe to the check valves on the reservoir.

Push the 10 mL of water from the syringe into the reservoir and then draw back on the syringe plunger to extract as much water as possible from the reservoir.

4.6.6 Disconnect Battery

Disconnect Battery: DISCONNECTED

Unplug the power from Ignis (Figure 18).

4.6.7 Remove Battery

Remove Battery: REMOVED

Remove the battery from the battery compartment as shown in Figure 14.

4.6.8 Inspect for Visible Damage

Inspect for Visible Damage: NO DAMAGE

See Section 4.1.3

4.6.9 Store in Case

Store in Case: STORED

Store all components in the storage case making sure to follow the storage guidelines in Section 1.12.

5 Emergency Procedures

This section contains the emergency procedure checklists. See the Amplified Emergency Procedures in Section 6 for details.

5.1 Communication Failure Checklist

1. **Stop Ignitions and Dropping:** SWITCHES OFF, SYSTEM STOPPED
2. **Alert Operators and Bystanders:** ALERTED
3. **Visually Verify Dropping Stopped:** DROPPING STOPPED

If dropping does not stop and the drone is under control, keep the drone over an area where ignitions are safe before proceeding to next step.

4. **Return Drone to Landing Zone and Land:** LANDED
5. **Perform Post Flight Inspection:** COMPLETE

5.2 In-Flight Fire Checklist

1. **Check for In-Flight Fire:** FIRE SUSPECTED
2. **Disarm Ignis:** DISARMED
3. **Fly Over Safe Ignition Area:** OVER SAFE IGNITION AREA
4. **Trigger Dropper Emergency Ejection:** BOTH ROTATED CLOCKWISE, EJECTED
5. **Return Drone to Landing Zone and Land:** LANDED
6. **Perform Post Flight Inspection:** COMPLETE

5.3 Stuck Ignition Sphere After Landing Checklist

1. **Remove Needle Assemblies:** NEEDLES REMOVED
2. **Trigger Dropper Emergency Ejection:** BOTH ROTATED CLOCKWISE, EJECTED
3. **Battery Disconnect:** DISCONNECTED
4. **Manually Remove Stuck Ignition Sphere:** REMOVED

6 Amplified Emergency Procedures

6.1 Communication Failure Checklist

If there is a communication failure between Ignis and the drone or between the ground station and the Drone/Ignis the system should automatically stop ignitions.

6.1.1 Stop Ignitions and Dropping

Stop Ignitions and Dropping: SWITCHES OFF, SYSTEM STOPPED

Press the Stop button in the app to stop dropping. To also disarm Ignis in order to prevent accidentally starting again, move the Arm/Disarm switch (S3) on the control bar into the disarm position (down and away from the user), as shown in Figure 4. This will safely stop dropping at any point, although additional ignition spheres may be dispensed as they are cleared from the chutes. Note that the stopping process can take 5-10 seconds while the system purges any additional ignition spheres and performs a calibration process.

6.1.2 Alert Operators and Bystanders

Alert Operators and Bystanders: ALERTED

Alert all personnel in the area of the loss of communications.

6.1.3 Visually Verify Dropping Stopped

Visually Verify Dropping Stopped: DROPPING STOPPED

If dropping does not stop and the drone is under control, keep the drone over an area where ignitions are safe before proceeding to next step.

Verify visually that dropping and ignitions have stopped. If it has not stopped and the drone is under control, keep the drone over an area where ignitions are safe before proceeding to next step. If it has not stopped and the drone is not under control, then prepare for potential fire ignitions along the route of flight.

6.1.4 Return Drone to Landing Zone and Land

Return Drone to Landing Zone and Land: LANDED

Return the drone to the landing zone and land. During this process pay particular care to watch for any ignitions in the area.

6.1.5 Perform Post Flight Inspection

Perform Post Flight Inspection: COMPLETE

Perform the steps in the post flight inspection in Section 4.5.

6.2 In-Flight Fire Checklist

6.2.1 Check for In-Flight Fire

Check for In-Flight Fire: FIRE SUSPECTED

Check for abnormally high Ignis temperature, or use the camera to look for smoke or flames coming out of Ignis. If a fire is suspected, continue this checklist. If not, continue with regular operations (if applicable) or return to land as soon as it is safe to do so.

6.2.2 Disarm Ignis

Disarm Ignis: DISARMED

Move S3 on the control bar into the disarmed position (down and away from the user). This will automatically cause Ignis to stop dropping.

6.2.3 Fly Over Safe Ignition Area

Fly Over Safe Ignition Area: OVER SAFE IGNITION AREA

Fly over an area where it is safe for there to be a ground fire to prevent unintended ignition of other areas.

6.2.4 Trigger Dropper Emergency Ejection

Trigger Dropper Emergency Ejection: BOTH ROTATED CLOCKWISE, EJECTED

Rotate both dials fully clockwise within 2 seconds of each other to trigger the emergency release as shown in Figure 34. Or, use the Emg. Release button in the App to trigger an emergency release.

This will cause the Dropper to be ejected and dropped from the Hopper, preventing the spreading of any fire to the Hopper or drone.

6.2.5 Return Drone to Landing Zone and Land

Return Drone to Landing Zone and Land: LANDED

Return the drone to the landing zone and land. During this process pay particular care to watch for any other inflight fires.

6.2.6 Perform Post Flight Inspection

Perform Post Flight Inspection: COMPLETE

Perform the steps in the post flight inspection in Section 4.5.

6.3 Stuck Ignition Sphere After Landing Checklist

6.3.1 Remove Needle Assemblies

Remove Needle Assemblies: NEEDLES REMOVED

Remove the needle assemblies (Section 4.1.19). This will ensure that no antifreeze can be injected into the ignition sphere.

6.3.2 Trigger Dropper Emergency Ejection

Trigger Dropper Emergency Ejection: BOTH ROTATED CLOCKWISE, EJECTED

Rotate both dials fully clockwise within 2 seconds of each other to trigger the emergency release as shown in Figure 34. Or, use the Emg. Release button in the App to trigger an emergency release.

6.3.3 Battery Disconnect

Battery Disconnect: DISCONNECTED

Unplug the power from Ignis (Figure 18).

6.3.4 Manually Remove Stuck Ignition Sphere

Manually Remove Stuck Ignition Sphere: REMOVED

Manually remove the stuck ignition sphere. Proceed to the post-flight inspection (Section 4.5).

7 Ignis Android App

7.1 System Requirements

The app is compatible with Android Lollipop (5.0) and above. The Android operating system can be upgraded by going to Settings, About, System update.

Minimum System Requirements:

Operating System: Android Lollipop (5.0)

CPU: Quad-Core, 1.2 GHz

RAM: 1GB

Recommended System Requirements:

Operating System: Android Nougat (7.0)

CPU: Quad-Core, 1.5 GHz

RAM: 2GB

The app is compatible with the following DJI™ drones:

- INSPIRE™ 1
- INSPIRE™ 1 Pro
- INSPIRE™ 1 RAW
- INSPIRE™ 2
- MATRICE™ 100
- MATRICE™ 600
- MATRICE™ 600 Pro
- PHANTOM™ 3 Standard
- PHANTOM™ 3 4K
- PHANTOM™ 3 Professional
- PHANTOM™ 3 Advanced

- PHANTOM™ 4
- PHANTOM™ 4 Pro
- PHANTOM™ 4 Advanced
- MAVIC™ Air
- MAVIC™ Pro
- MAVIC™ 2 Pro
- MAVIC™ 2 Zoom
- MAVIC™ 2 Enterprise
- MAVIC™ 2 Enterprise Dual

DJI™, INSPIRE™, MATRICE™, PHANTOM™, and MAVIC™ are trademarks of DJI.

7.2 Privacy and Versions

The Ignis app has two main versions: a general-purpose version, and a privacy-enhanced version. The DJI SDK that this app uses to control a DJI drone can potentially upload flight logs to DJI's servers. The privacy-enhanced version of this app implements a firewall to ensure that no data will be leaked by the DJI SDK over the internet. The general-purpose version is recommended for customers without this concern, and allows for an internet-connection during flight so maps can be automatically downloaded during flight. Besides this, there are only a few minor differences between the versions, and these will be pointed out in the following sections. See section 7.11 to learn more about the privacy-enhanced version.

7.3 Main Menu



Figure 45: Main Menu of Ignis app.

The first time you launch the app, you will be asked to agree to the End User License Agreement, and to give the app certain permissions. The app can function without the Location permission, but it will not be able to display your device's location on the map. The other permissions are necessary for the DJI Mobile SDK to operate, and to save files such as flight logs to an accessible location on your device.

When the app is launched, a screen similar to Figure 45 will be displayed. If you are using the privacy-enhanced version of the app, these menu options are split across two apps. Press the FLY button on the first screen to see the other options. Status and error messages will display at the bottom of the screen, such as whether or not the app is connected to the remote controller or drone.

7.3.1 First Time Registration

In order to use the app to fly a DJI drone, the DJI Mobile SDK used by the app must be registered. This process is automatic. However, for first-time registration, the app must be connected to the internet. After the app has successfully registered once, it can be used without an internet connection.

In the privacy-enhanced version of the app, the first-time registration process must be manually started, and will temporarily disable the firewall. Follow the instructions displayed on the main menu.

7.3.2 Connecting the Remote Controller

When you connect the remote controller to your mobile device using a USB cable, you may see a prompt to pick which app should be opened when this USB accessory is connected. If you do see this prompt, select this app, and the status at the bottom of the main screen will change to either: "Connect to drone: Failure (Disconnected from drone)" if the drone is not on, or "Connect to drone: Success" if the drone is on.

If you do not see this pop-up and another app automatically opens, that app may have been selected as the default app to open. Go to your Android device's Settings, Apps, and click on that app. Next, to the Open by default setting for that app, and clear defaults. Now, reconnect the controller, and you should see the prompt.

7.4 Settings

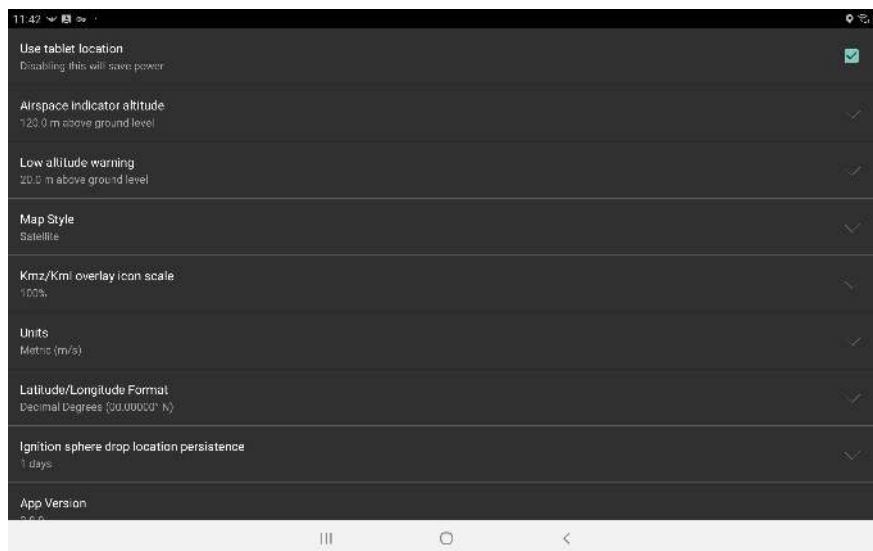

Figure 46: App Settings

Pressing the “SETTINGS” button from the main menu will open a screen where the app's settings can be changed, shown in Figure 46. The following is a description of each setting:

Use Tablet Location If this is enabled, the app will utilize the tablet's location capabilities to display the user's location on the map, in addition to the GPS in the lightbridge controller (if any). Location must also be enabled on the tablet for this to work. However, locating the device will consume a significant amount of the tablet's battery power.

Airspace indicator altitude This is the height above ground level of a visual guide you can see when planning waypoint missions. This can be set to your aviation administration's mandated maximum altitude above ground level that drones can fly at, which assists with compliance.

Low altitude warning This is the height above ground level of a visual guide you can see when planning waypoint missions. This can be set to the height of nearby trees or obstacles, which helps you fly at a safe altitude. If the drone flies below this altitude, a low altitude warning will be displayed on the screen, and a warning tone will play. The warning tone plays a low (440Hz) tone followed by a high (620Hz) tone four times.

Map Style Sets the map style to use. You can choose between Satellite and Streets, Outdoors (Topographic), Satellite, and Streets. When you download maps, they will be downloaded in this style.

Kmz/Kml overlay icon scale Scales up or down icons that are part of Kmz and Kml overlays.

Units The app's units can be set to Metric (km/h), Metric (m/s), Imperial (mi/h), Imperial (ft/s), or Nautical (kn). Speeds are displayed in the units that are in the parenthesis. Other units are displayed in Metric (m, C, hectares) or Imperial units (ft, F, acres).

Latitude/Longitude Format Changes the format that latitudes and longitudes will be displayed in. Options are: Decimal Degrees; Degrees, Decimal Minutes; and Degrees, Minutes, Seconds.

Ignition sphere drop location persistence Adjusts how long ignition sphere drop locations will be saved for. After this many days, the locations will be erased the next time you restart the app. Press the clear drop locations button to clear all of them now.

EULA and Privacy Policy This will display the app's EULA and Privacy Policy at https://droneamplified.com/agreements/EULA_beta.html

Ignis Manual Displays the latest Ignis manual at <https://droneamplified.com/downloads/IgnisManual.pdf>

All Applications Settings Use this when another app has been selected as the default app to open when the USB to the remote controller is connected to the tablet. This button opens up the Android settings app to the all applications screen, which shows a list of all of your applications. Find the application that is automatically opening, and

click on it. You should see a section that says “Open by Default”, “Launch by Default”, or “Defaults”, and inside that will be a button that says “Clear Defaults”. Press that button. Then, reconnect the USB cable and you should be prompted to select the application to connect to the USB cable.

7.5 Download Maps

This app uses Mapbox for its satellite imagery and maps. Mapbox provides high-resolution satellite imagery across the globe, and allows users to download maps for offline usage. This allows for flight in locations that have no internet connection.

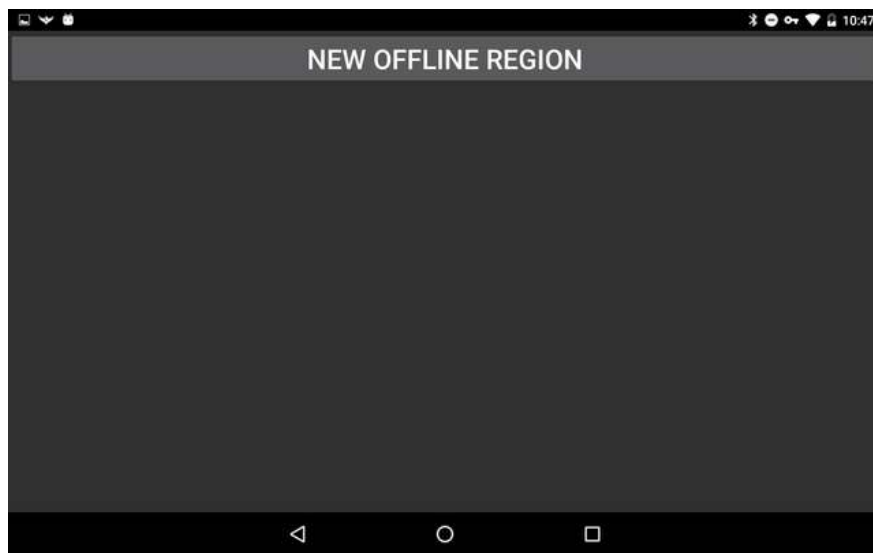

Figure 47: Offline Regions Screen

Pressing the “DOWNLOAD MAPS” button on the main menu will open a screen similar to Figure 47. This screen will display all of the maps you’ve downloaded, but it is currently empty in this Figure.

7.5.1 New Offline Region

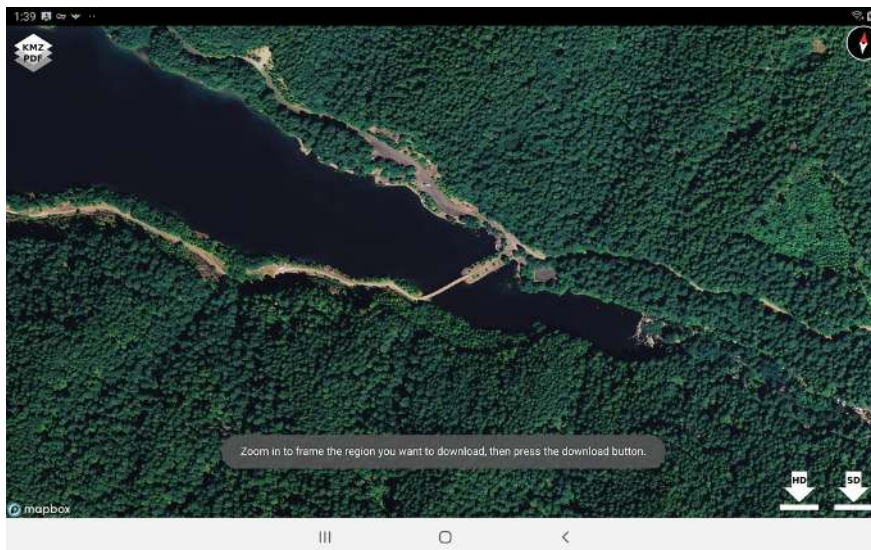

Figure 48: Selecting a region to download

Pressing the “NEW OFFLINE REGION” will open a screen that shows a map of the world. Zoom in, translate, and rotate the map until the region that should be downloaded is displayed on the screen. You can press the “KMZ / PDF” button to select a map overlay to display, which can help you find the region you want to download. Once the map has been zoomed in far enough, download buttons will appear in the bottom right corner of the screen, as shown in Figure 48. You have options to download “High Definition” imagery or “Standard Definition” imagery of the viewed region. The “High Definition” imagery is the most detailed imagery available for that region, but results in a large download. Touch one of the download buttons to start downloading all of the map tiles in that region in the current style. If you have Satellite selected as your map style preference, then the map on this screen will display Satellite and Streets to make it easier to locate regions to download, but it will only download the Satellite images.

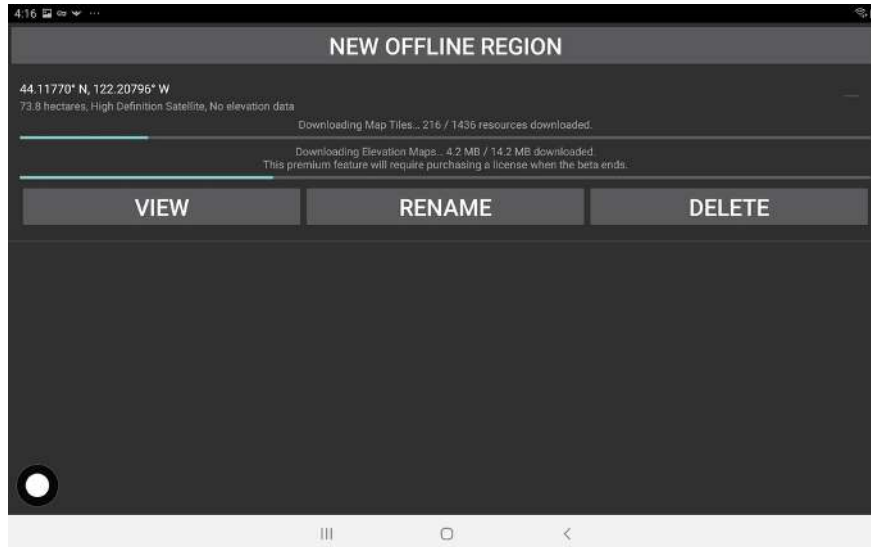

Figure 49: Downloading a region

After pressing the download button, the app will return to the previous screen, shown in Figure 49, where the download progress will be displayed. While the region is downloading, the app can be used to start downloading another region, or for other functions by navigating to other screens in the app. Don't close the app while a download is in progress, or the download may not complete. In the event the app was closed before a download was completed, the region should be deleted and re-downloaded, as it may not contain map tiles of the entire region.

After the app has downloaded the map tiles for the region, it will download elevation maps for the region as well, as shown in Figure 5. While this is downloading, you can leave this screen and use the app for other things. However, if the app is closed, then the download will fail. If the download fails for any reason, then the app will attempt to redownload the elevation maps once every minute. Once the elevation map download for the region completes, the "No elevation data" note on the right side of the screen will change to "Full elevation data".

Each elevation map file covers a large area of 1 degree of longitude by 1 degree of latitude, and requires between 1 and 15 Megabytes of storage space. These files are stored on your mobile device in the directory /Drone Amplified/Elevation Maps. You can free up storage space by deleting this directory or the individual elevation map files within it.

We would like to note that the ability of the app to download elevation map files from our servers will not be a free feature once the app leaves its open beta state, but it is provided for free during the open beta for testing.

7.5.2 Managing Regions

Each downloaded region appears in a list below the “NEW OFFLINE REGION” button. These entries give some basic information about the location, size, and zoom levels of the map. If an entry in the list in the list is touched, it will expand to display the progress of any downloads related to it, as well as display “VIEW”, “RENAME”, and “DELETE” buttons.

Pressing the “DELETE” button will start the deletion process for that region. Please wait until the deletion is completed. This button can also be used to stop downloading satellite imagery for region.

Any number of regions can be downloaded, but there is a limit to the number of map tiles that are allowed to be saved by Mapbox. If the download fails because the Mapbox Tile Count limit was exceeded, try deleting a few other regions to free up space.

Pressing the “RENAME” button will allow you to rename the region so you can easily identify it later. Once you are done typing in the new name for the region, press the “SAVE CHANGES” button to save the new name, or press the “CANCEL CHANGES” button to go back to the previous name.



Figure 50: Viewing a downloaded region

Pressing the “VIEW” button will show the downloaded region, as in Figure 50. However, this isn’t an accurate representation of what tiles are saved for offline usage, as Mapbox will download tiles to fill this view in if the app is connected to the internet. Additionally, Mapbox will cache tiles that have been recently viewed, so it’s possible that tiles that haven’t been explicitly downloaded can be viewed offline. Disconnect from the internet, then view the region to get a better idea of what tiles are downloaded.

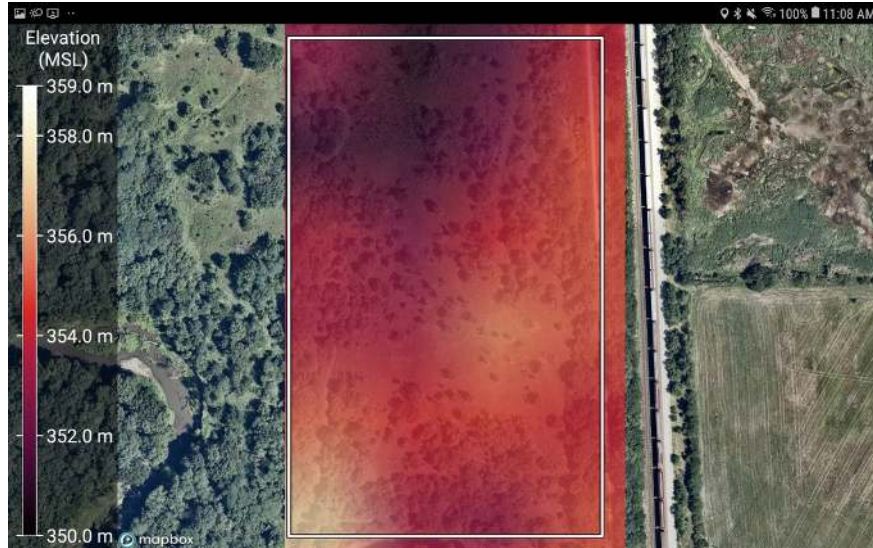

Figure 51: Viewing the elevation of a downloaded region

If you touch the map while viewing an offline region, it will show the elevation of the region above mean sea level, as shown in figure 51. Touch the map again to hide it.

7.5.3 Elevation Data

The elevation maps used in this app are from the Shuttle Radar Topography Mission (SRTM), which collected elevation data of the Earth's surface between 60 degrees north and 56 degrees south latitudes in February of 2000. The data points are posted every 1 arc-second (approximately 30 meters), with 1 meter of height resolution. Areas above 50 degrees north and below 50 degrees south are sampled at a resolution of 2 arc-second by 1 arc-second. Some map tiles may contain voids. For more information, see <https://www.usgs.gov/centers/eros/science/usgs-eros-archive-digital-elevation-shuttle-radar-topography-mission-srtm-1-arc>

Additional data sets may be incorporated in the future.

7.6 Map Overlays

PDF files with georeferenced maps (such as those created by Esri ArcMap), KMZ files, KML files, and CSV files with latitude and longitude columns can be displayed as an overlay on the map while flying.



Figure 52: Map Overlays Screen

Pressing the “MAP OVERLAYS” button on the main menu will open a screen similar to Figure 52. This screen will display all of the map overlays loaded by the app, but it is currently empty in this figure.

If you’ve download some georeferenced pdf, kmz, kml, or csv files onto your mobile device, then you can load them by pressing the “ADD OVERLAY FILE” button. This opens a file browser so you can navigate to the file on your device, as shown in Figure 53. The flight log csv files that the app automatically creates are also properly formatted for this app to import.

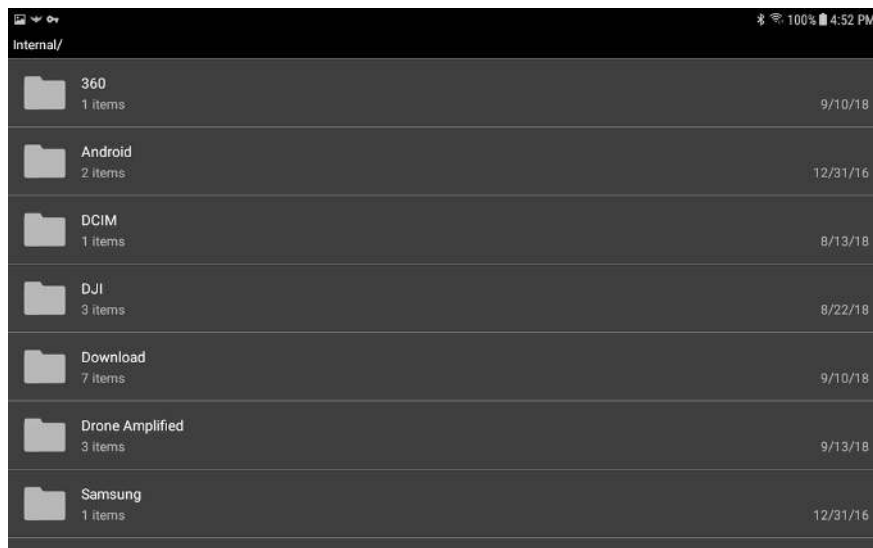

Figure 53: File browser for selecting a file to use as a map overlay

Touch a folder in the file browser to see its contents. Press the back button on your device's navigation bar to go back up a directory. If you downloaded the file, it is likely inside the Download folder. If you want to import a flight log, those are located inside "Drone Amplified/Flight Logs/".

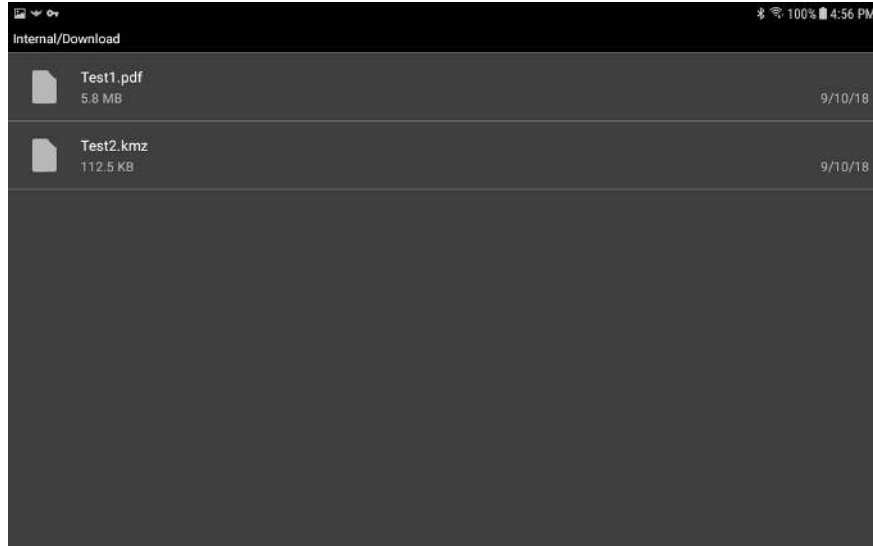

Figure 54: Browsing the Download folder for pdf and kmz files

Figure 54 shows a pdf and kmz file inside the Download folder. Touch a file to select it. This will return to the Map Overlays Screen, and the app will start processing that file, as shown in Figure 55. If an error occurs, it will be reported here.

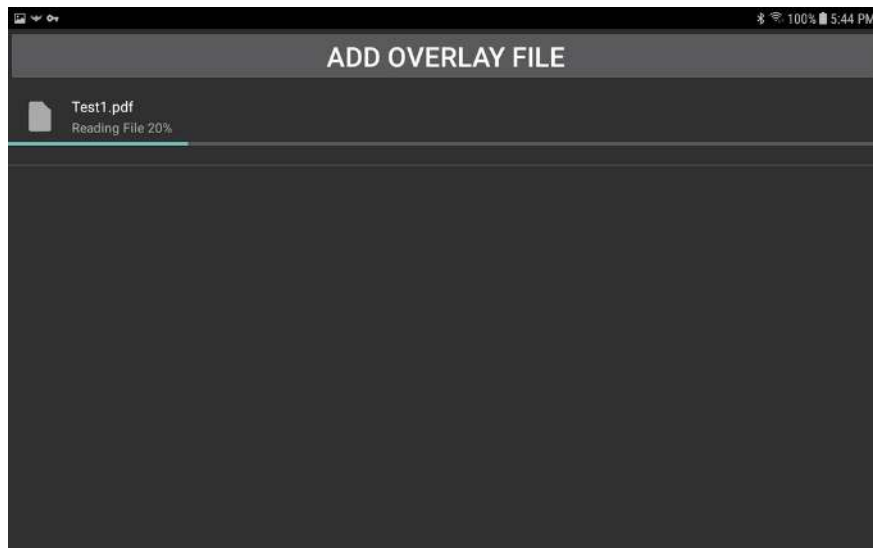

Figure 55: Processing a pdf file so it can be displayed as an overlay

Once the file is processed, it will appear in a list below the “ADD OVERLAY FILE” button, as shown in Figure 56. This list is persistent, and you do not need to re-process all of these overlays every time you start the app. When you fly, you will be able to select the overlay you want to display on the map.

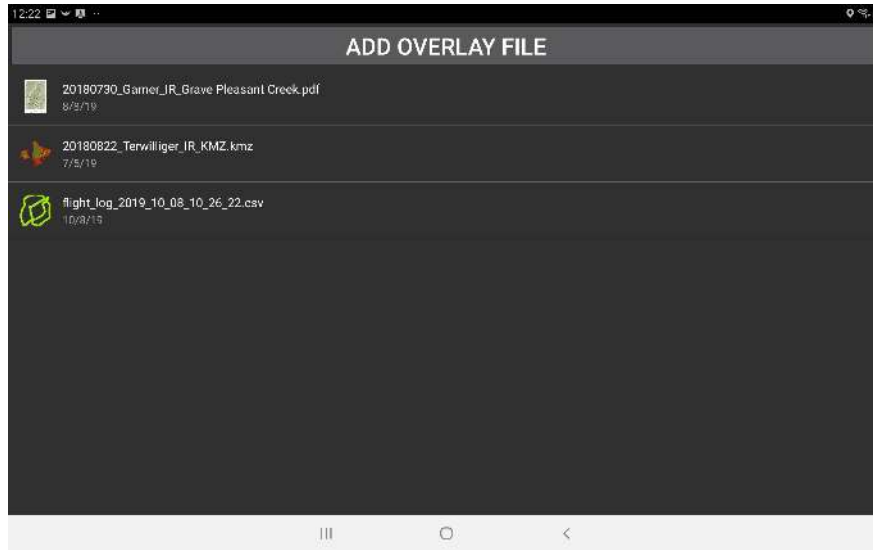

Figure 56: A pdf, kmz, and flight log that have been processed by the app into overlays

The list can also be used to manage the overlays. Clicking on an overlay will allow you to view it on a map, or remove it from the list, as shown in Figure 57.

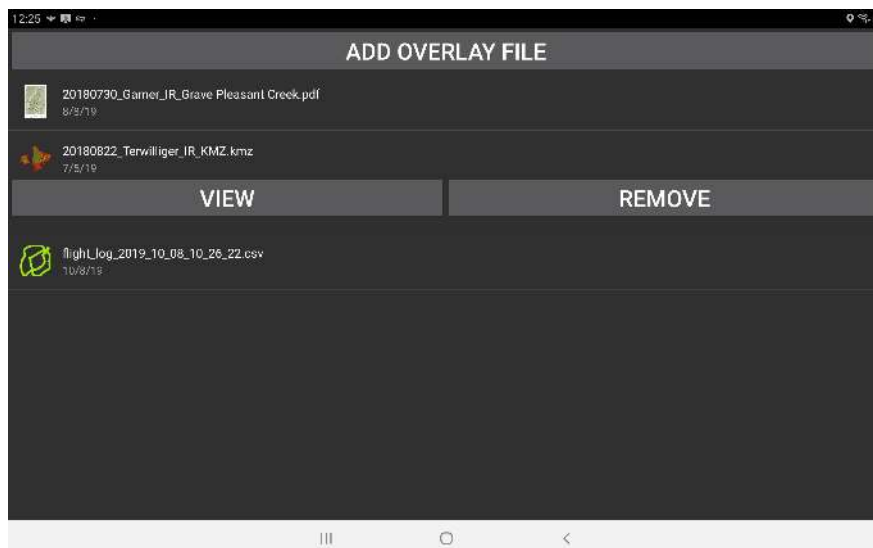

Figure 57: Touching an overlay will allow you to view it on a map or remove it from the list.

Viewing the overlay will allow you to see it on the map, as shown in Figure 58. Touch the screen to hide or show the overlay.



Figure 58: Viewing a kmz overlay

Remove overlays from the list when you have no further use for them.

7.7 Drone Setup

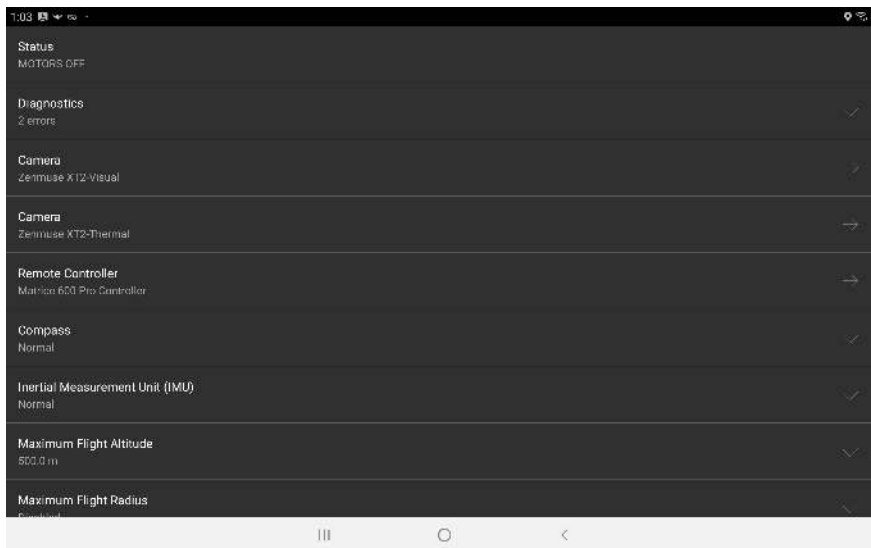

Figure 59: Drone Setup

Pressing the "DRONE SETUP" button from the main menu will open a screen where the drone's settings can be changed, and advanced information can be viewed. You must be connected to a drone in order to view this. The following is a description of each setting:

Status Displays the overall status of the drone, as you would see if you were flying.

Diagnostics Displays DJI errors and warnings produced by the drone.

Camera Indicates what model of DJI Camera is connected to the drone. Clicking on this will take you to settings for the camera.

Remote Controller Clicking on this will take you to settings for the remote controller.

Compass Displays information about the compass, and allows you to perform a compass calibration.

Inertial Measurement Unit (IMU) Displays information about the Accelerometer(s) and Gyroscope(s) on the aircraft. IMU calibration is currently under development.

Maximum Flight Altitude Allows you to adjust the drone's maximum allowed flight altitude above its takeoff point.

Maximum Flight Radius Allows you to adjust the drone's maximum allowed distance from home. Move the slider all the way to the right to disable this.

Low Battery Warning Threshold Sets the battery percentage that will make the controller start beeping. This doesn't affect the low battery procedure.

Critical Battery Warning Threshold Sets the battery percentage that will make the controller start beeping rapidly. This doesn't affect the low battery procedure.

Low Battery Procedure Sets the procedure the drone will follow when it gets low on battery. You can choose between "Land in place with a 10% battery buffer", or "Go home and land with a 10% battery buffer". If "Go home" is the selected procedure, and the drone reaches a point where it determines it only has enough battery to return home and land with a 10 % battery procedure, a prompt will appear in the app asking you to either confirm or cancel the drone's request to go home. If you take no action within 10 seconds, then the drone will automatically return home. The app may also ask you to confirm the automatic landing. Note that if the drone is already within 20 meters of the home point, it will land in place instead of going directly over the home point. See the RTH Safety Notices in your drone's manual for other considerations.

Lost Link Procedure Sets the procedure the drone will follow if it loses connection with the remote controller. You can choose between "Hover", "Land", or "Go Home". See the RTH Safety Notices in your drone's manual.

Minimum Go Home Altitude If the drone is below this altitude when the Go Home procedure is initiated, it will first ascend to this altitude before returning home.

Video Feed Configuration This setting is only available on the Matrice 600, and gives you 4 options to quickly configure which video feed gets streamed from the Lightbridge 2. You can select between “Zenmuse”, “HDMI”, “AV”, and “HDMI & AV”. Configuring the video feed on the Matrice 600 is quite buggy. If this quick configuration doesn’t work, you can try the advanced controls, which are enabled by the checkbox at the bottom that says “Show advanced controls”.

Primary Video Feed Source and Bitrate This is part of the advanced video feed configuration controls. This shows what source the primary video feed will display, as well as how many kilobytes per second are currently being received from this video feed.

Secondary Video Feed Source and Bitrate This is part of the advanced video feed configuration controls. This shows what source the secondary video feed will display, as well as how many kilobytes per second are currently being received from this video feed.

EXT Video Input Port This is part of the advanced video feed configuration controls. Enabling this will allow the use of a Zenmuse camera. Disabling this will only use the video feeds from the HDMI and AV sources.

LB / EXT Video Bandwidth Allocation This is part of the advanced video feed configuration controls. This adjusts the bandwidth allocation between the LB and EXT sources. If you are using a Zenmuse camera, and have enabled the EXT video input port and set a reasonable bandwidth allocation, but you still don’t see any video feed from the Zenmuse camera, then lower this bandwidth allocation down to 0% LB and leave it there for a few seconds before raising it again. This usually fixes the issue, and is the procedure the app takes when selecting the Zenmuse quick configuration.

HDMI / AV Video Bandwidth Allocation This is part of the advanced video feed configuration controls. This adjusts the bandwidth allocation between the HDMI and AV sources.

HDMI / AV Transmission Mode This is part of the advanced video feed configuration controls. This changes the transmission mode of the HDMI/AV camera between high quality, or low latency.

Model The model of the drone

Drone Name A user-settable name for the drone.

Flight Controller Serial Number The serial number of the drone's flight controller.

Flight Controller Firmware Version The flight controller's firmware version. This is not the same as the version number of the firmware package on DJI Assistant 2.

7.7.1 Camera Settings

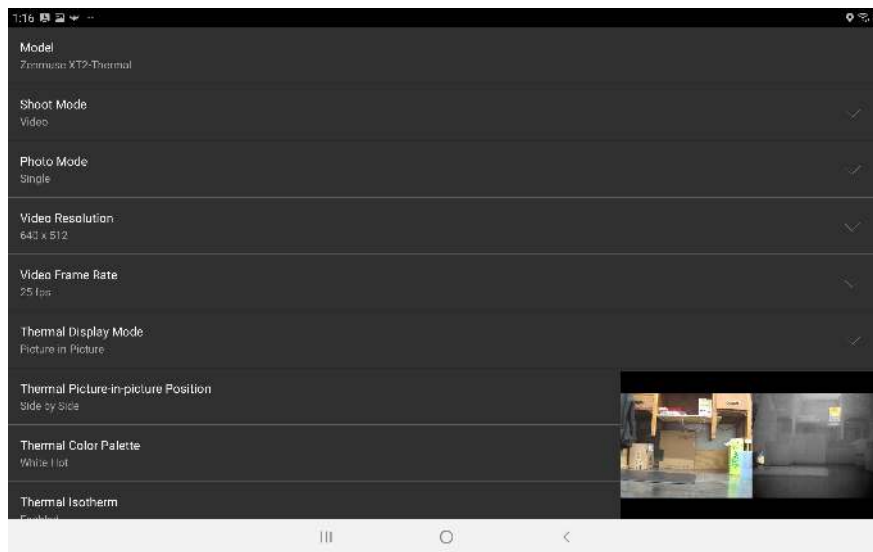

Figure 60: Thermal Camera Setup

If a DJI camera is connected to the drone, then you will see a Camera setting in the Drone setup menu that displays the model of the camera. If you touch this, you will go to a new screen with settings for that camera. Currently, these settings are implemented:

Model Displays the model of the camera.

Shoot Mode Switches between photo and video mode

Photo Mode Changes what kind of pictures you take while in photo mode. Refer to your camera's manual to find out what options it supports.

Video Resolution Selects the resolution that the video files will be saved at. Refer to your camera's manual to find out what options it supports.

Video Frame Rate Selects the frame rate that the video files will be saved at. Due to DJI bugs, you may be able to select options that your camera doesn't actually support. Refer to your camera's manual to find out what options it actually supports.

Restore Factory Settings This will cause the camera to restore its factory settings and restart.

The following settings appear if you are viewing the settings for a thermal camera (e.g. Zenmuse XT2 IR).

Thermal Display Mode This allows you to switch the display between Visible-only, Thermal-only, Picture-in-picture, or MSX. MSX will display the thermal video feed, but sharpen edges by using the visible camera.

Thermal Picture-in-picture position This allows you to change the position of the thermal video feed in Picture-in-picture display mode.

Thermal Color Palette Changes between different color palettes.

Thermal Isotherm Enables or disables isotherm color palettes. Isotherm palettes use a different color scale for temperatures between certain ranges.

Isotherm Lower Temperature Pixels below this temperature will use the normal color gradient of the palette.

Isotherm Middle Temperature Pixels between the lower temperature and the middle temperature will use a second color gradient.

Isotherm Upper Temperature Pixels between the middle temperature and the upper temperature will use a third color gradient. Pixels above this temperature will use a fourth color gradient.

MSX Visibility Adjusts how transparent or opaque the sharpened edges from the MSX effect appear.

Measurement Mode This option allows you to measure the temperature at specific points in the video feed, and is only supported by radiometric thermal cameras. Disabled will not show any temperature measurement. Spot Metering will show the temperature of a fixed point on the screen. Area Metering will show the highest and lowest temperature points in a region of the screen.

Area Metering Screen Region Selects the region of the screen that is processed in the Area Metering Measurement Mode. You can select the Entire Screen, Bottom Half, Middle Ninth, or Center Point.



Figure 61: Maximized camera view. Area Metering is enabled, and the app shows crosshairs over the hottest and coldest parts of the video feed.

For easy configuration, the video feed will be displayed in the corner of this screen. Touching the video will maximize or minimize it, as shown in Figure 61. While it is maximized, you can drag your finger across the screen to pan or tilt the gimbal, and pinch the screen to zoom.

7.7.2 Remote Controller Settings

Left Wheel Function Changes which gimbal axis the left wheel on the remote controller controls. Roll may not be supported by your drone.

Left Wheel Sensitivity Adjusts the speed that the left wheel rotates the gimbal at.

C1 Button Function Pressing the C1 button on the controller will have this function while the app is connected. Note that these functions are implemented by the app and won't work if no app is connected to the remote controller.

C2 Button Function Pressing the C2 button on the controller will have this function while the app is connected. Note that these functions are implemented by the app and won't work if no app is connected to the remote controller.

C1/C2 Button Gimbal Speed When C1 or C2 is configured to rotate the gimbal, this is the speed the C button will rotate the gimbal at.

Remote Controller Name A user-settable name for the remote controller. Maximum 6 characters.

Remote Controller Serial Number The serial number of the remote controller.

Remote Controller Firmware Version The remote controller’s firmware version.

7.8 Flight Logs

Flight logs are generated in a csv format and are saved in:

Drone Amplified/Flight Logs

The specification of the flight log format is described in this document: https://droneamplified.com/downloads/android/flight_log_specification.pdf

More features involving flight logs are currently under development.

7.9 Ignis Setup

7.9.1 Connection Options

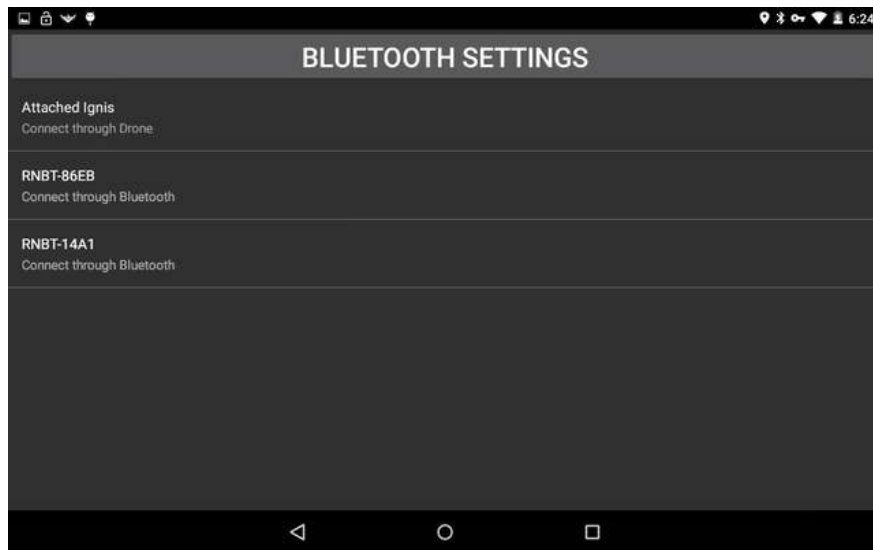

Figure 62: Ignis Setup connection options.

Press the “IGNIS SETUP” button on the main menu to open up the Ignis connection options screen, shown in Figure 62. Below the “BLUETOOTH SETTINGS” button is a list of the ways to connect to Ignis. Each bluetooth device the tablet is paired to is listed, as well as an option to connect to Ignis through the drone.

7.9.2 Bluetooth Settings

Pressing the “BLUETOOTH SETTINGS” button will open up the Android device’s bluetooth settings. This screen can be used to enable Bluetooth, scan for nearby devices, and pair with them. The password to pair with Ignis is 1234. Ignis must be paired before it can be connected to through Bluetooth.

7.9.3 Connecting through Bluetooth



Figure 63: App when connected to Ignis 1 through Bluetooth.

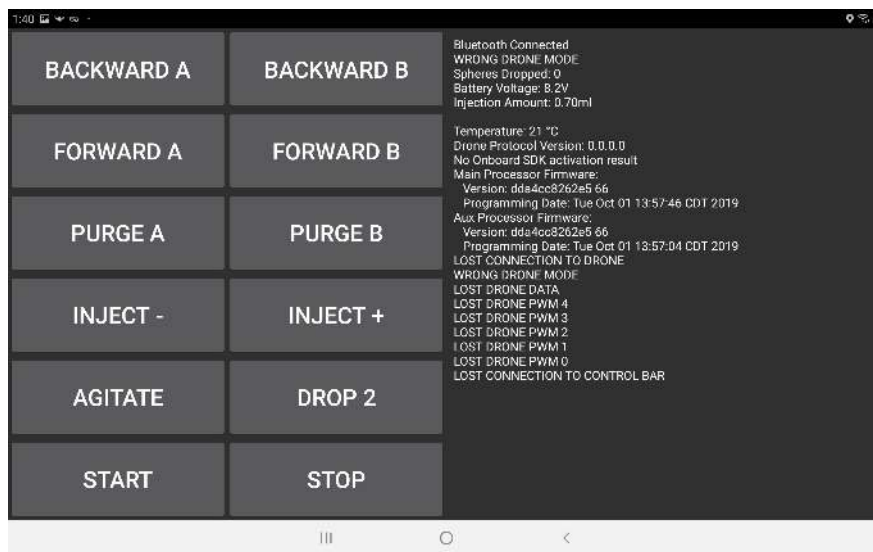

Figure 64: App when connected to Ignis 2 through Bluetooth.

To setup Ignis through Bluetooth, first find Ignis's Bluetooth address located in the battery cover or on the case, then touch the corresponding name in the connection option screen shown in Figure 62. This will open a screen similar to Figure 64. While the app is attempting to connect to Ignis, the status will display "Bluetooth Disconnected", and will change to "Bluetooth Connected" once it connects. This may take up to 10 seconds. If you are having trouble connecting via Bluetooth, try turning the drone off, as its radio can interfere with the Bluetooth connection, or just connect through the drone. Once the app begins to receive messages from Ignis, Ignis's status will be displayed on the right, as shown in Figure 64. The following is a description of each button:

EMPTY A (Ignis 1 only) Completely empties syringe A.

EMPTY B (Ignis 1 only) Completely empties syringe B.

FILL A (Ignis 1 only) Completely fills syringe A.

FILL B (Ignis 1 only) Completely fills syringe B.

BACKWARD A (Ignis 2 only) Sucks air from the A side needle into the reservoir.

BACKWARD B (Ignis 2 only) Sucks air from the B side needle into the reservoir.

FORWARD A (Ignis 2 only) Injects a large amount of liquid from the A side. Use this to quickly prime the needle with antifreeze from the reservoir.

FORWARD B (Ignis 2 only) Injects a large amount of liquid from the B side. Use this to quickly prime the needle with antifreeze from the reservoir.

PURGE A Injects a small amount of liquid from the A side. Use this repeatedly to clear any last air out of the tubes and needle before taking off.

PURGE B Injects a small amount of liquid from the B side. Use this repeatedly to clear any last air out of the tubes and needle before taking off.

INJECT - Decreases the injection amount of A and B by 0.1 mL.

INJECT + Increases the injection amount of A and B by 0.1 mL.

AGITATE Spins the hopper motor for a short period. Use this to make sure ignition spheres get into the chutes before takeoff.

DROP 2 Injects and drops 2 ignition spheres. Use this to test dropping while on the ground.

START Starts dropping. Use this to test dropping while on the ground.

STOP Stops dropping.

7.9.4 Connecting through the Drone



Figure 65: App when connected to Ignis 1 through the Drone.

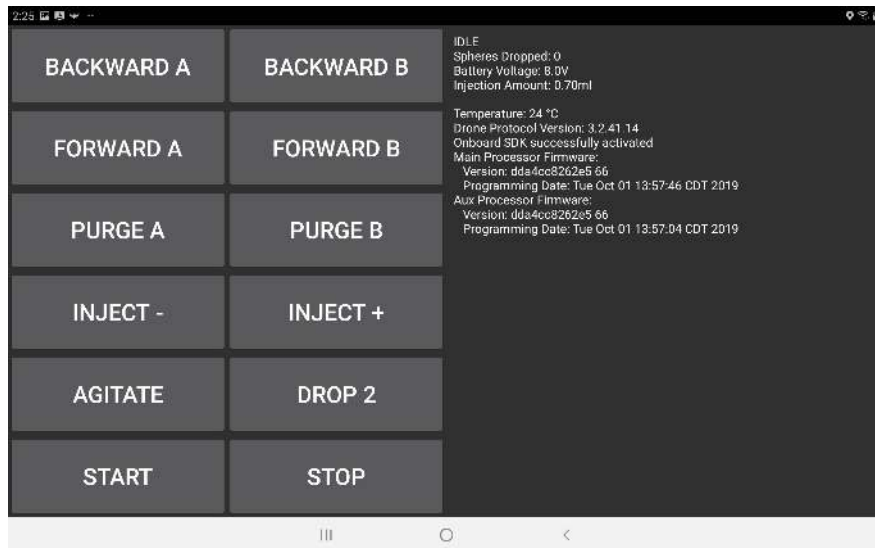

Figure 66: App when connected to Ignis 2 through the Drone.

In case Ignis cannot be connected through Bluetooth, there is the option to setup Ignis through the drone. Make sure Ignis is connected to the drone, the drone is on, the controller

is on, the tablet is connected to the controller, and the app says it is connected to the drone. If the app is receiving messages from Ignis, then the option to connect through the drone will appear as in Figure 62. Touch this option to connect to Ignis through the drone, which will open up a screen similar to 66.

7.10 Flying

Touching the “FLY” button from the main menu will open the screen used to fly the drone and control Ignis. Figure 67 shows an example of this flight screen, and enumerates important interface elements.

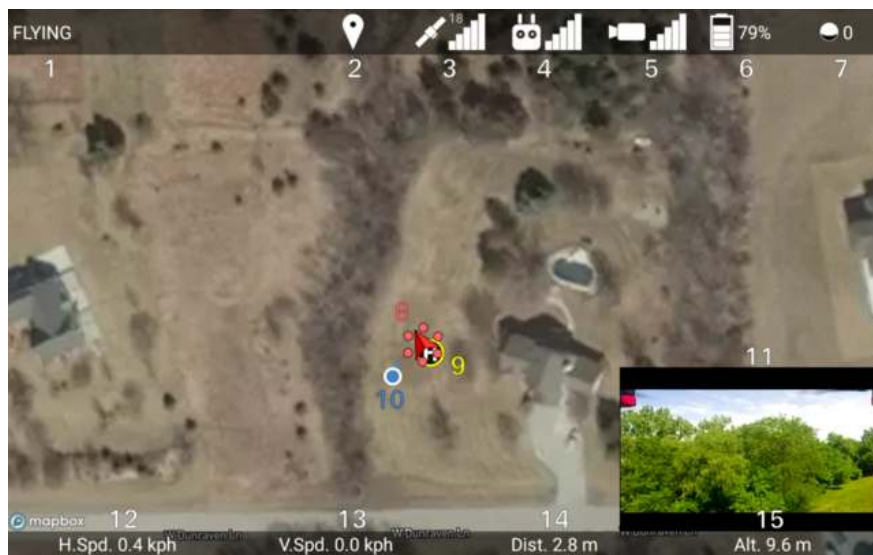

Figure 67: Main interface elements while flying.

This screen puts Android into Immersive mode, and hides the navigation and status bars. In order to back out of this screen, swipe down from the top to reveal the status and navigation bars, then press the back button.

The following is a description of the enumerated interface elements shown in Figure 67.

1. Overall Drone Status This can be one of several states:

DISCONNECTED The drone is not connected.

IMU PREHEATING The inertial measurement unit is preheating. Please wait for it to finish.

COMPASS ERROR The compass cannot accurately identify the drone’s position.

MOTORS OFF The motors are off.

MOTORS ON The motors are on.

GOING HOME The drone is returning home or auto-landing. Use the go-home button on the controller to leave this state.

FLYING The drone is flying and is under the control of the remote controller.

WAYPOINTS The drone is following programmed waypoints. In this state, the remote controller can only yaw the vehicle, or use the pitch control to adjust the drone's velocity along the waypoint path. If a failure occurs in the DJI Mobile SDK while the vehicle is following waypoints, or waypoints are being uploaded to the vehicle, then there is a possibility that the app will report the state as WAYPOINTS when the drone is actually FLYING, or vice versa. Use the "Stop" button under the Waypoints Menu, or switch the controller into P mode to leave the WAYPOINTS state and regain manual control of the drone.

2. **Waypoints Menu Button** Touching this icon will open up the Waypoints Menu.
3. **Map Menu Button & GPS Signal Strength** Touching this icon will open the Map Recentering Menu. This icon also shows the strength of the GPS signal the drone is receiving, as well as the number of satellites it is receiving signal from.
4. **Auto Takeoff / Auto Landing Menu Button & Uplink Signal Strength** Touching this icon will open the Auto Takeoff / Auto Landing Menu. This icon also shows the strength of the radio signal from the remote controller to the drone.
5. **Camera Menu Button & Downlink Signal Strength** Touching this icon will open the Camera Menu. This icon also shows the strength of the radio signal from the drone to the remote controller, which primarily carries video signal.
6. **Battery Menu Button & Lowest Battery Level** Touching this icon will open the Battery Menu. This icon also displays the lowest energy percent remaining of all the batteries in the drone.
7. **Ignis Menu Button & Number of Ignition Spheres Dropped** Touching this icon will open the Ignis Menu. This icon will spin while Ignis is dropping. If Ignis is connected, the ? will display the number of ignition spheres that have been dropped.
8. **Drone Location and Attitude** This marks the location and orientation of the drone. The icon will also pitch and roll to reflect the attitude of the drone. Touching this will toggle Focus mode, which will center the drone in the screen, and is convenient for manually flying the drone with the controller.

9. **Home Location** This is the location that distance is measured relative to, and where the Drone will fly to if the Go Home procedure is initiated.
10. **User Location** This will display if the “Display User Location” setting is enabled, and Location enabled on the tablet. This blue and white dot displays the location of the user. A blue triangle adjacent to the dot indicates which direction the user is facing.
11. **Live Video Feed** This displays the video being streamed from a camera connected to the Drone’s HDMI or AV port. Touching this will maximize it. Touching this while it is maximized will return it to normal size.
12. **Drone Horizontal Speed** Displays the horizontal component of the speed of the drone.
13. **Drone Vertical Speed** Displays the vertical component of the velocity of the drone.
14. **Horizontal Distance between Drone and Home** Displays the horizontal component of the distance between the drone and the home point.
15. **Altitude of Drone** Displays the altitude of the drone above the takeoff location. If the app has elevation maps for this area, then it will also display the altitude above ground level in parenthesis.

You can zoom, rotate, and translate the map using touch gestures. When the map is rotated, a compass will appear in the top right corner. Touch the compass to reorient the map so that north is up.



Figure 68: Touch a location on the map while no other menus are open, and an info bubble about that location will appear. Touch the info bubble to hide it.

If you tap a location on the map, information about that point will be displayed, as shown in Figure 68. This will show the latitude, longitude, altitude of the ground above the takeoff location, elevation above mean sea level, and horizontal distance from the home point. Some information will not be displayed if it cannot be calculated. Touch the info bubble again to hide it.

7.10.1 Map Menu

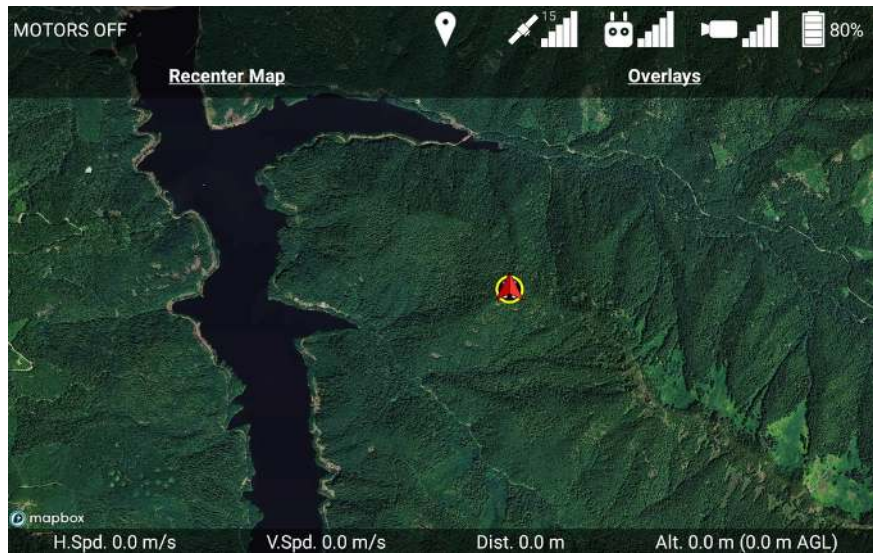

Figure 69: Map Menu

Touching the GPS satellite icon at the top of the screen will open the Map Menu, shown in Figure 69.

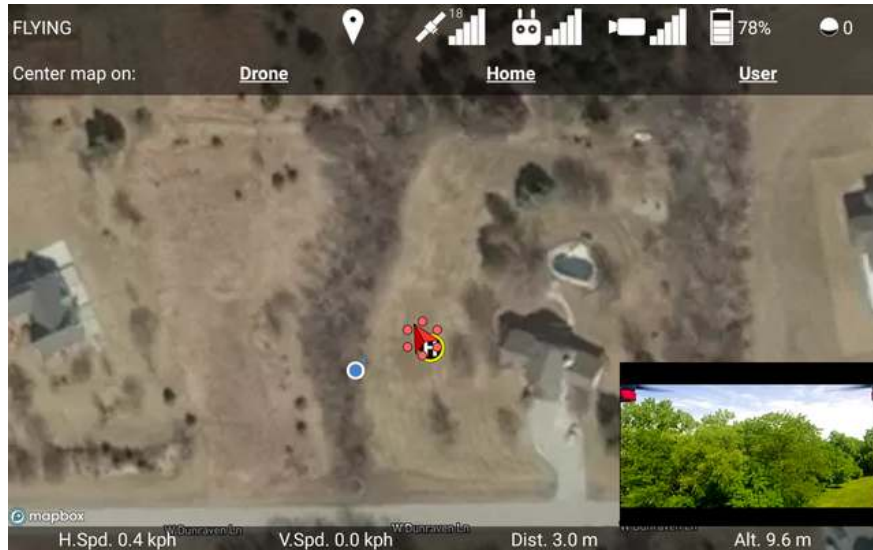

Figure 70: Map Recentering Menu

The “Recenter Map” button will open the Map Recentering Menu, shown in Figure 70. If you do not have any map overlays loaded, touching the GPS satellite icon will directly open the Map Recentering Menu. Touch either “Drone”, “Home” or “User” to recenter and rezoom the map on that. Touch the map or the menu button again to close this menu.

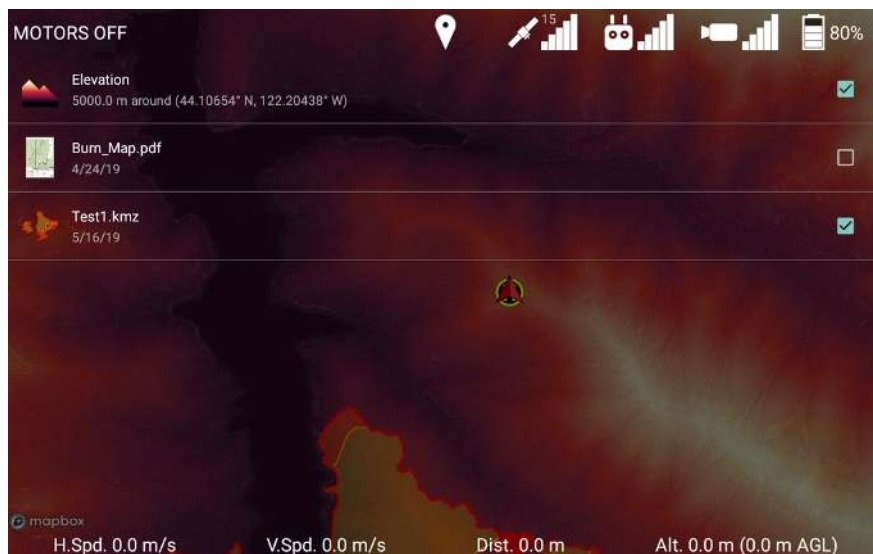

Figure 71: Overlays List

The “Overlays” button will open a list of all of the overlays that are displayable by the app, shown in Figure 71. This includes a colorized elevation overlay and any georeferenced pdf or kmz/kml files that have been imported. Touch the checkbox to toggle the display of that overlay. Press the GPS satellite icon at the top to get out of this screen.

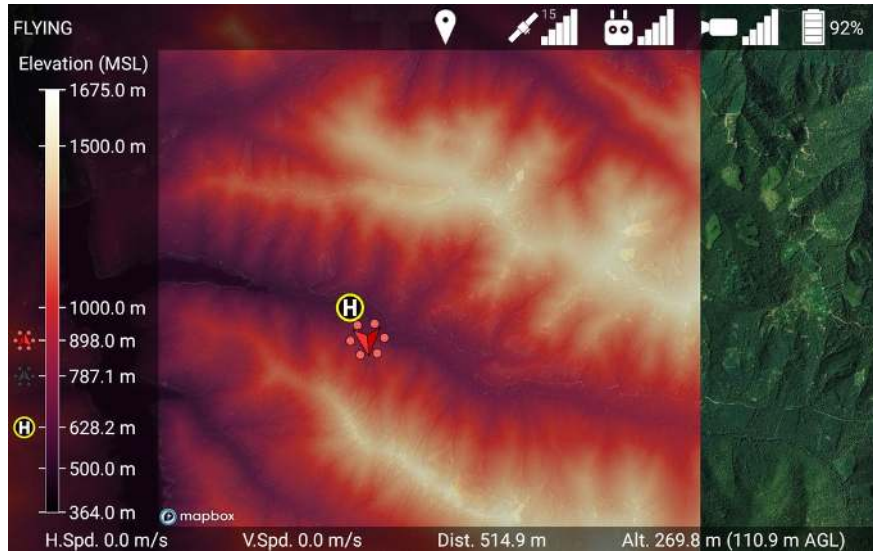

Figure 72: Viewing elevation maps while flying

When the Elevation overlay is enabled, the map will display a colorized elevation map of the nearby region and a legend that indicates what elevation above mean sea level the colors correspond to, as shown in Figure 72. If you are flying, then the legend will also display the elevation of the home point, the drone, and the terrain directly below the drone. In Figure 72, these are the white “H” in a yellow circle at 628.2 m, the red drone icon at 898.0 m, and the black drone icon (representing the drone’s shadow) at 787.1 m, respectively.

The app will automatically reload a larger region of elevation maps if you fly too close to the edge of the currently loaded region, or place waypoints outside the current region. Additionally, the app will automatically attempt to download elevation maps for the region you are flying in if you have an internet connection, and have not already downloaded elevation maps for that region.

We would like to note that once the app leaves open beta, this automatic downloading of elevation maps from our servers will become a feature that must be paid for. It is provided for free during open beta for testing.

7.10.2 Auto Takeoff / Auto Landing Menu

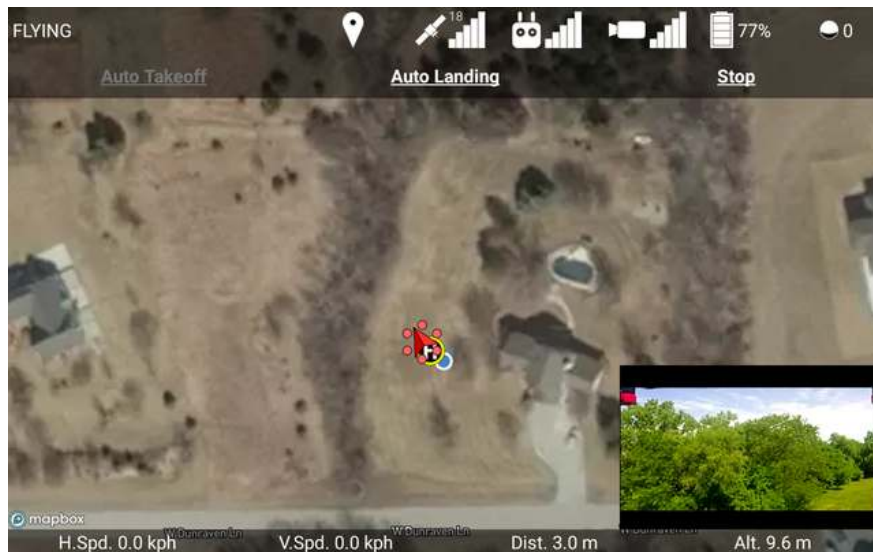

Figure 73: Auto Takeoff / Auto Landing Menu

Touching the controller icon at the top of the screen will open the Auto Takeoff / Auto Landing Menu, shown in Figure 73. Touch “Auto Takeoff” when it is white to initiate an automatic takeoff. This will make the drone hover 1 meter above the ground. Touch “Auto Landing” when it is white to initiate an automatic landing. This will make the drone slowly descend in-place until it reaches the ground, after which it will turn off its motors. The controller can also be used to guide the drone as it lands. The Go-Home button on the controller can also cancel the Auto Landing. Touch “Stop” to stop an automatic takeoff or landing. Touch the map or the menu button again to close this menu.

7.10.3 Camera Control

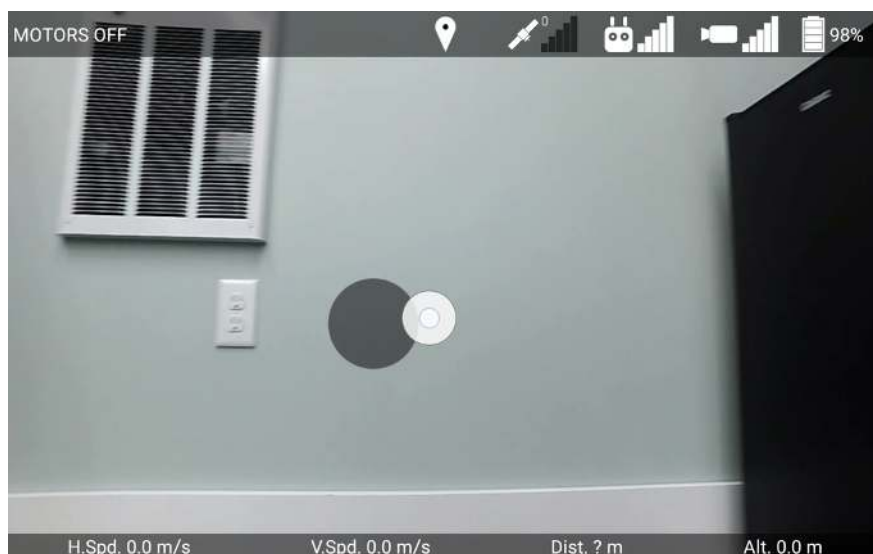

Figure 74: Moving the gimbal with a virtual joystick in the maximized camera view

Touching the minimized video feed in the corner of the screen will maximize the video feed so it fills the screen, as shown in Figure 74. Dragging your finger along the maximized camera view will create a virtual joystick that you can use to move the camera on the drone around with the gimbal.

Touching the camera view in two places and bringing them further apart will increase the digital zoom level (on cameras that support digital zoom). Bringing your fingers closer together will decrease the digital zoom level.

Touch the video feed once to minimize it again and reveal the map.

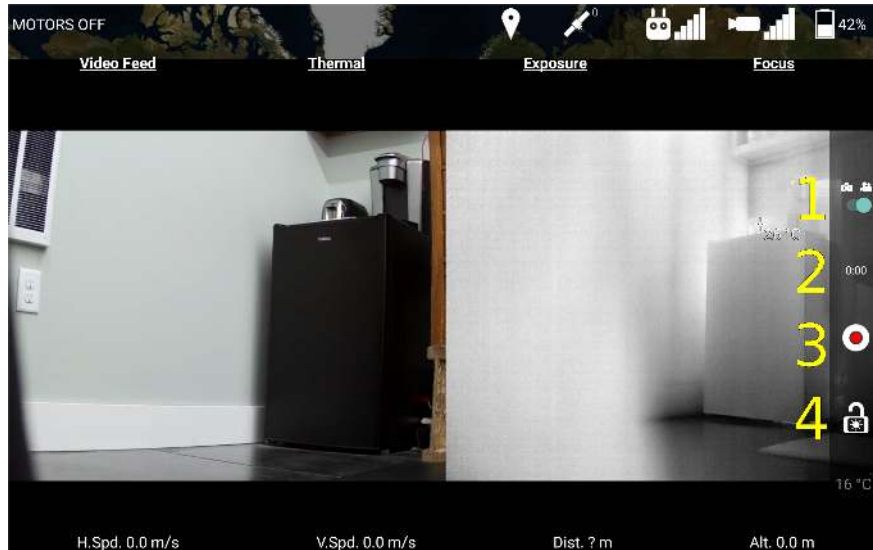

Figure 75: Camera menu

Touching the video camera icon at the top of the screen will open the Camera Menu, shown in Figure 75.

Additionally, if the drone has a DJI camera, a sidebar with some camera controls will appear. The sidebar's camera controls are enumerated in yellow in Figure 75, and a description of each button is below.

1. **Camera Mode Switch** Use this switch to change the camera between photo mode (left), and video mode (right).
2. **Photo Capture Mode / Recording Time** If the camera is in photo mode, this displays the capture mode (Single or Burst). If the camera is in video mode, this displays how many minutes and seconds have been recorded by the current recording.
3. **Start / Stop Capture Button** If the camera is in photo mode, press this button to take a picture. If the camera is in video mode, press this button to start recording. While recording, this button will change into a white circle around a red square. Press this button again to stop recording.
4. **Toggle Auto Exposure Lock Button** If this icon is unlocked, the camera can automatically adjust its exposure. If this icon is locked, the camera will not change its current ISO / shutter / aperture settings. Touch this button to toggle this state.

The camera menu shows options for changing the Video Feed, the Exposure, the Focus, and the Photo Mode. The exposure, focus, and photo mode can only be adjusted on DJI

cameras. If no DJI camera is connected, the Camera Menu will instead show the Video Feed Menu.

If a thermal camera is connected, you will see an additional “Thermal” option, which will allow you to change between Visible, IR, Picture in Picture, or Multi-Spectral Dynamic Imaging (which enhances the IR view with edges detected by the visible camera), as shown in Figure 76.

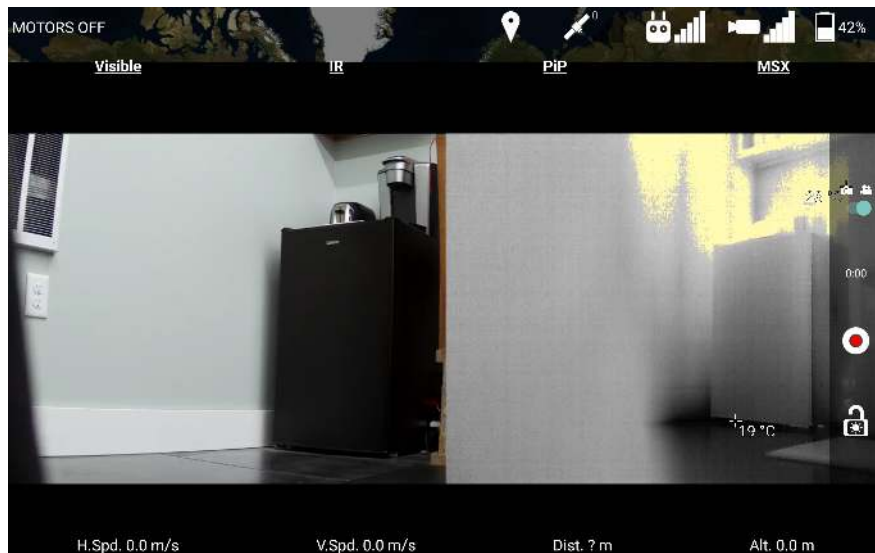

Figure 76: Thermal Menu

Touching the Video Feed option from the Camera menu will show the Video Feed Menu, shown in Figure 77.

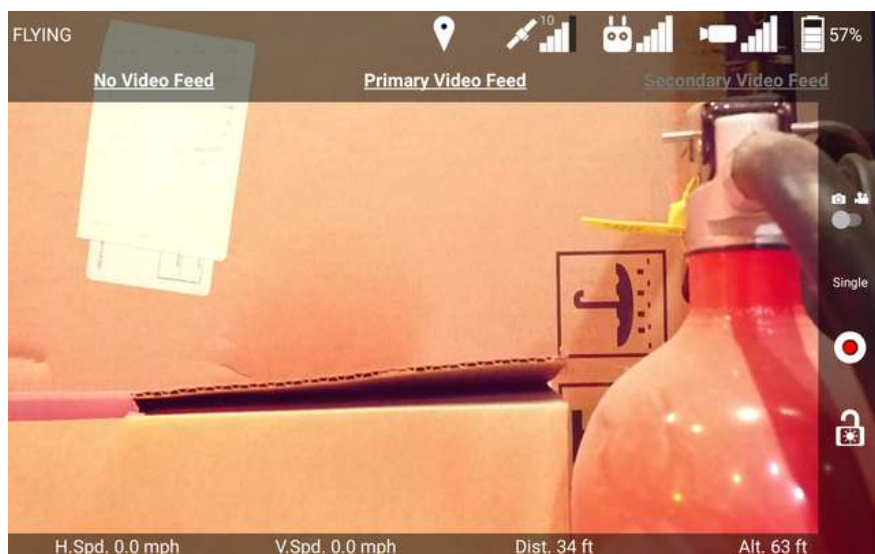

Figure 77: Video Feed Menu

Touch either “Primary Video Feed”, or “Secondary Video Feed” to display video from that source. If the app isn’t receiving any data from the Primary or Secondary, then that option will be grayed out. The “No Video Feed” option will remove the video display from the interface.

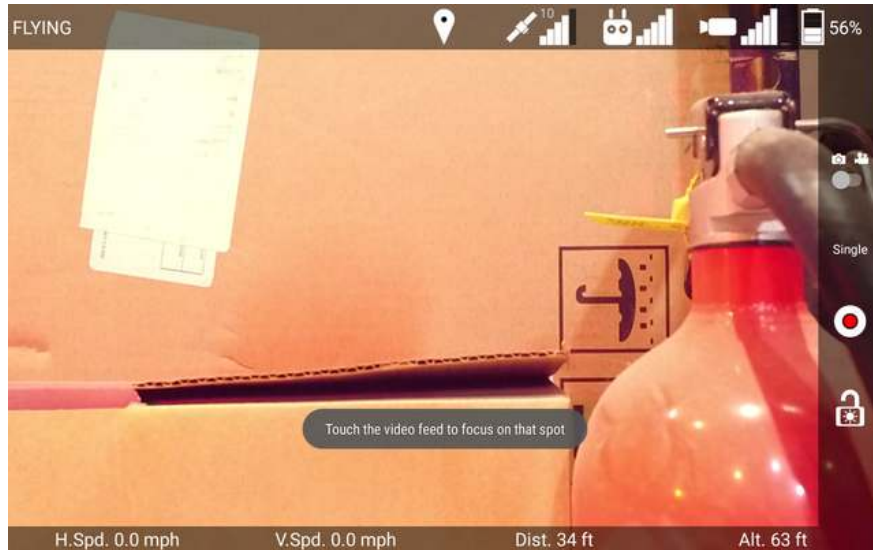

Figure 78: Instructions to focus the camera.

The video feed will automatically maximize when you choose to Focus the camera. The next time you touch the video feed, the camera will automatically focus on that point. Touching the video feed again will have the normal minimizing/maximizing functionality.

Touching the Exposure option from the Camera menu will show the Exposure Menu, shown in Figure 79.

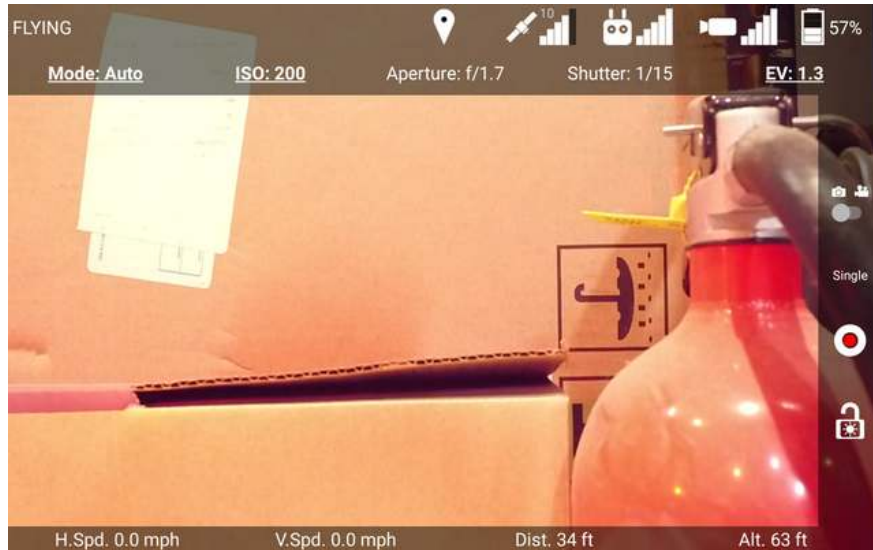

Figure 79: Exposure Menu

This menu shows the current mode, ISO, aperture, shutter, and exposure compensation settings. Depending on the current exposure mode, different settings are adjustable. The adjustable settings are indicated by being bolded and underlined. In Auto mode, as in Figure 79, the ISO and EV can be adjusted.

Touching the Mode option will open the Exposure Mode Menu, shown in Figure 80.

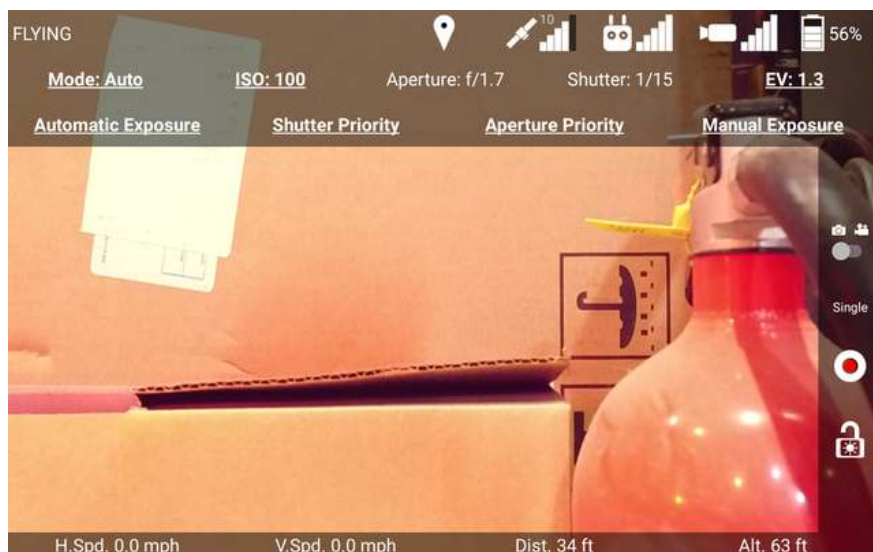

Figure 80: Exposure Mode Menu

This menu lets you change between the four exposure modes:

Automatic Exposure Allows you to manually adjust ISO and exposure compensation. Aperture and shutter are manually adjusted.

Shutter Priority Allows you to manually adjust ISO, shutter, and exposure compensation. Aperture is automatically adjusted.

Aperture Priority Allows you to manually adjust ISO, aperture, and exposure compensation. Shutter is automatically adjusted. Not all DJI cameras support Aperture Priority mode.

Manual Exposure Allows you to manually adjust ISO, aperture, and shutter. You cannot set ISO to Auto in this mode.

Touching the ISO option in the Exposure Menu will open the ISO setting selector, shown in Figure 81.

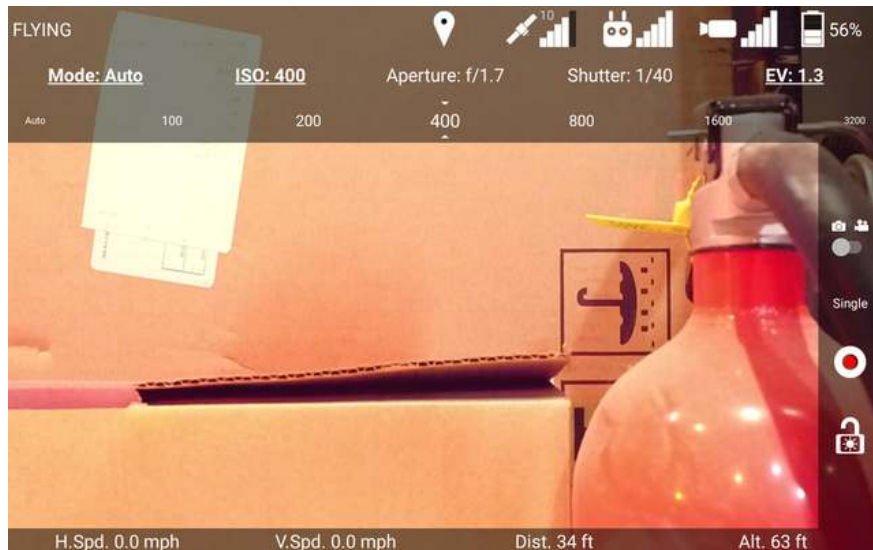

Figure 81: ISO Setting Selector

Swipe left and right along the ISO setting selector to scroll through the possible values. The ISO will be set to the center setting, which is contained within the two indicator triangles. In Automatic Exposure, Shutter Priority, and Aperture Priority modes, you also have the option to set ISO to Auto.

Aperture, Shutter, and EV can be set using a similar scrolling interface. However, not all cameras will support all aperture and shutter values.

7.10.4 Battery Menu

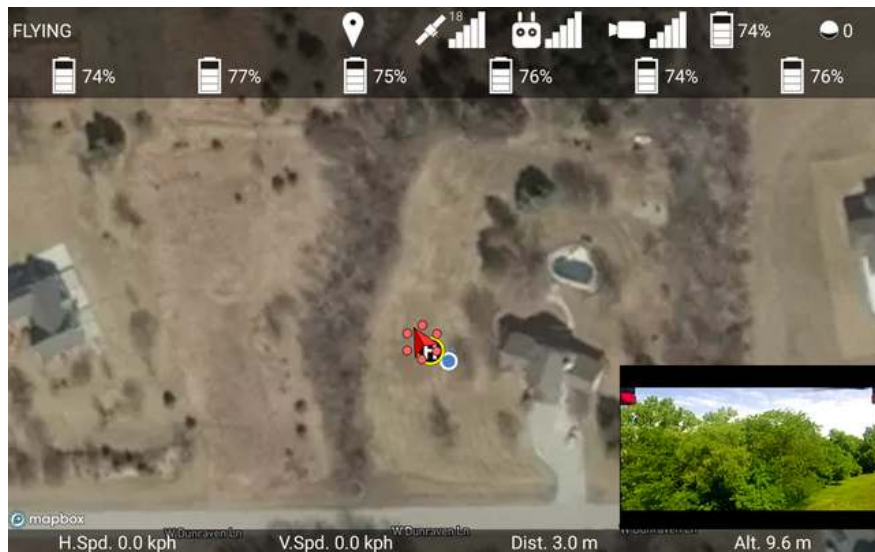

Figure 82: Battery Menu

If the drone has multiple batteries, then touching the battery icon at the top of the screen will open the Battery Menu, shown in Figure 82. This displays the energy percent remaining in each battery on the drone. Touch the map or the menu button again to close this menu.

7.10.5 Ignis Menu

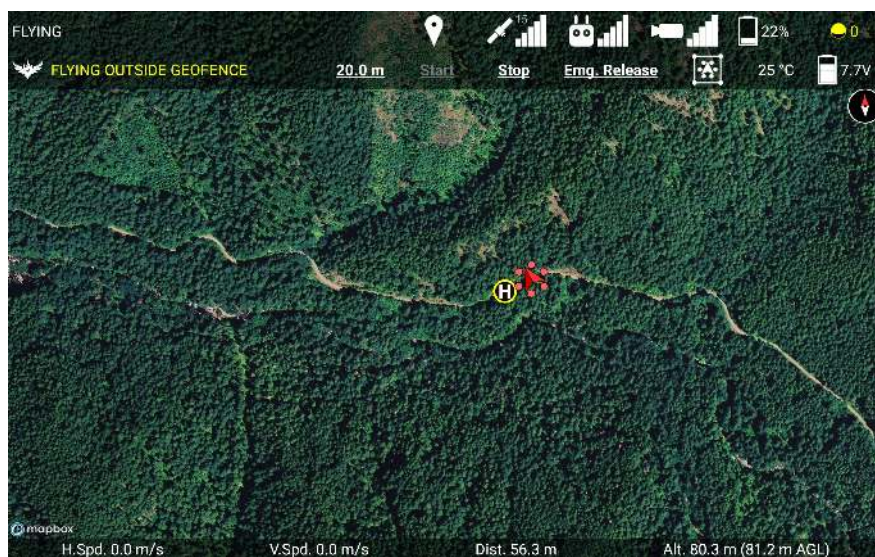

Figure 83: Ignis Menu

Touching the ignition sphere icon at the top right of the screen will open the Ignis Menu, shown in Figure 83. This displays the current status of Ignis, as well as the temperature sensor reading, and the battery voltage. The Ignis's status could display the following messages:

HIGH TEMP ... Ignis's temperature sensor is detecting a high temperature above the injection chamber. An ignition sphere may have caught fire inside the dropper. Trigger an emergency release to separate the dropper from the rest of the aircraft. The ellipsis would display other information about Ignis's status.

IDLE Ignis is currently idle, and has no errors to report.

IDLE (STOPPED B/C ...) Ignis is currently idle, but stopped dropping because of an error. The ellipsis would display the reason why Ignis stopped. Try restarting dropping.

FILLING Ignis is currently filling, and has no errors to report.

FILLING (STOPPED B/C ...) Ignis is currently filling, but stopped dropping due to an error. The ellipsis would display the reason why Ignis stopped. Try restarting dropping.

DROPPING Ignis is dropping.

DROPPING AND FILLING Ignis is dropping, and one or two syringes are refilling. During this period, fewer ignition spheres will be dropped.

DISARMED BY CONTROL BAR The control bar Arm/Disarm switch is in the Disarm position. The switch must be moved to the Arm position in order to start dropping.

FLYING OUTSIDE GEOFENCE Dropping was disabled because the drone is flying in an area that is not enclosed by a geofence. Fly back inside the geofence, or modify the geofence to include the current flight area.

LOW BATTERY Ignis battery voltage dropped below a safe level (11.4 V on Ignis 1, 6.6 V on Ignis 2). Use the app to check that the battery voltage is above this safe level. If it is, and you don't need to drop many more ignition spheres, attempt to restart dropping. Otherwise, land and replace the battery. If Ignis is idle and the battery is close to or lower than the safe level, then dropping is not recommended, as the battery voltage will likely dip below the safe level while Ignis is puncturing an ignition sphere, which will trigger this error again.

NO CONNECTION TO IGNIS The app is not receiving messages from Ignis, and has disabled dropping. Reconnect the app to the controller. You will also see this message if you have not activated the Onboard SDK (See section 9.4).

LOST CONNECTION TO APP Ignis stopped receiving messages from the app, and disabled dropping. Reconnect the app to the controller.

WRONG DRONE MODE Remote controller was switched to mode A. Or, the drone lost connection to the remote controller. Switch the remote controller into mode P or F. Regain radio connection between the controller and the drone. This error may also occur if the drone's configuration in DJI Assistant 2 is incorrect. Verify the configuration in DJI Assistant 2 matches the configuration in 9.3.

LOST CONNECTION TO DRONE Ignis is not receiving any signals or messages from the drone. Check that the USB cable from Ignis is connected to the drone.

LOST DRONE PWM Ignis is no longer receiving PWM signals from the drone. Check that the green-wrapped cable is plugged into the flight controller.

LOST DRONE PWM 0 Ignis is no longer receiving one of the PWM signals from the drone. Check that the green-wrapped cable is plugged into the flight controller, and none of the wires are broken.

LOST DRONE PWM 1 Ignis is no longer receiving one of the PWM signals from the drone. Check that the green-wrapped cable is plugged into the flight controller, and none of the wires are broken.

LOST DRONE PWM 2 Ignis is no longer receiving one of the PWM signals from the drone. Check that the green-wrapped cable is plugged into the flight controller, and none of the wires are broken.

LOST DRONE DATA Ignis is no longer receiving messages from the drone's API port. Check that the blue-wrapped cable is plugged into the flight controller.

LOST CONNECTION TO DROPPER Ignis lost connection with one or all of its sub-boards on the dropper. Check that the USB cable between the hopper and the dropper is connected.

INJECTION A COMMS TIMEOUT Ignis lost connection with the A-side injection sub-boards on the dropper. Check that the USB cable between the hopper and the dropper is connected.

INJECTION B COMMS TIMEOUT Ignis lost connection with the B-side injection sub-boards on the dropper. Check that the USB cable between the hopper and the dropper is connected.

PUNCTURE COMMS TIMEOUT Ignis lost connection with the puncture sub-boards on the dropper. Check that the USB cable between the hopper and the dropper is connected.

EMERGENCY RELEASE TRIGGERED The emergency release has been triggered. Dropping is disabled until you power-cycle Ignis.

S1 NOT CCW Dropping is disabled because the knob on the control bar labeled “S1” is not twisted counter-clockwise all the way. This knob is used to trigger the emergency release, and Ignis will not allow dropping until this knob is ready. An emergency release is triggered when S1 and S2 are twisted all the way clockwise within 4 seconds of each other in order.

S2 NOT CCW Dropping is disabled because the knob on the control bar labeled “S2” is not twisted counter-clockwise all the way. This knob is used to trigger the emergency release, and Ignis will not allow dropping until this knob is ready. An emergency release is triggered when S1 and S2 are twisted all the way clockwise within 4 seconds of each other in order.

HATCH MOTION ERROR Dropping was stopped because one of the hatches had trouble moving. An ignition sphere may have jammed the hatch. Try restarting to see if the jam has been cleared. If the problem persists, land and inspect the hatches.

MOVE TIMEOUT Dropping was stopped and disabled because one of the injection or puncture motors had trouble moving. Dropping cannot restart until Ignis is power-cycled. Land and inspect the injection and puncture motors. This message will only appear on older versions of Ignis.

INJECTION A MOTION ERROR Dropping was stopped and disabled because the A-side injection motor had trouble moving. Dropping cannot restart until Ignis is power-cycled. Land and inspect the motor.

INJECTION B MOTION ERROR Dropping was stopped and disabled because the B-side injection motor had trouble moving. Dropping cannot restart until Ignis is power-cycled. Land and inspect the motor.

PUNCTURE MOTION ERROR Dropping was stopped and disabled because the puncture motor had trouble moving. Dropping cannot restart until Ignis is power-cycled. This error could lead to an in-flight fire if Ignis was not able to remove an injected sphere. Use the camera and temperature sensor to monitor for an in-flight fire and use the emergency release in that event. Land and inspect the motor.

UNKNOWN ERROR Dropping was stopped because of an error that the app did not understand. Try to restart dropping. Check that you are using the latest version of the app.

UNKNOWN HARD ERROR Dropping was stopped because of an error that the app did not understand, and cannot be restarted until Ignis is power-cycled. Land and inspect Ignis. Check that you are using the latest version of the app.

If these troubleshooting steps do not resolve the issue, contact Drone Amplified for support.

The status is normally displayed with white text, but the status may become yellow or red to emphasize errors. If the status is yellow, then Ignis is unable to start dropping. If the status is red, then Ignis may have encountered a hard error that disables dropping until Ignis is power-cycled. The status can also turn red if the temperature sensor is reading a temperature above 60 degrees Celsius.

If Ignis is dropping and stops because of an error, or if the temperature sensor starts to read a high temperature, then this menu will automatically open in the app, and the app will make 3 short beeps.

There are three or four buttons to manually control Ignis during flight. Touch the distance button ("20.0 m" in Figure 83) to configure the drop spacing (Ignis 2 only). Touch the "Start" button to start dropping. Touch the "Stop" button to stop dropping. Touch the "Emg. Release" button to open a confirmation menu. Then touch "Yes" to trigger Ignis's emergency release.

Touch the map or the menu button again to close the Ignis menu.

7.10.6 Geofencing



Figure 84: Geofencing Menu

Touching the boxed drone icon in the Ignis menu opens the Geofencing Menu, shown in Figure 84. While this menu is open, touching spots on the map will mark that location as a corner of the area constrain Ignis to. Touch each corner of the burn area in a clockwise or counter-clockwise order to specify the burn area. You can use the Undo and Clear buttons to remove corners that have been added. You can drag corners of the geofence to move them.

Ignis will not be allowed to drop if the drone is flying outside the geofenced area, or if the drone is flying and no geofenced area has been defined. If the drone leaves the geofenced area, Ignis will automatically stop dropping.

Touch the boxed drone icon again to close this menu.

7.10.7 Waypoints Menu

The remote controller must be in mode F in order for the drone to fly along waypoints.

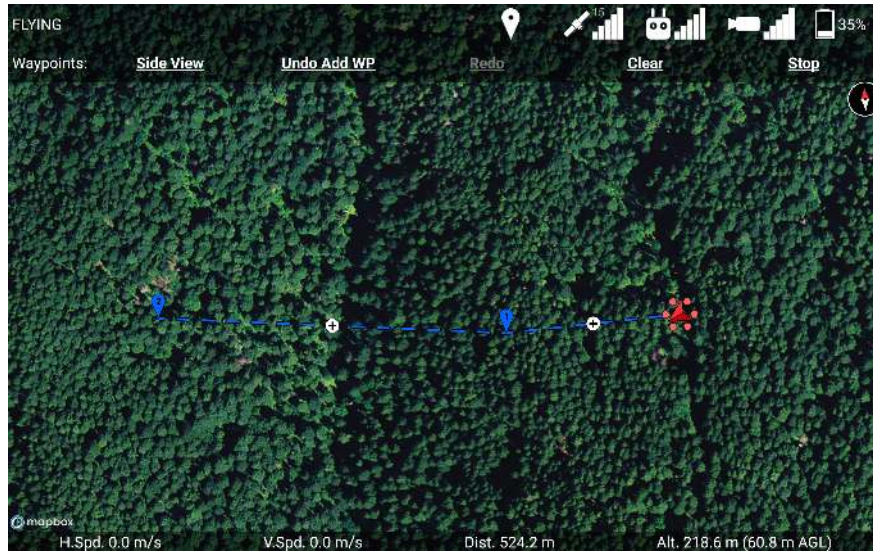

Figure 85: Waypoints Menu

Touch the Waypoint icon at the top of the screen to open the Waypoint Menu.

While the Waypoint Menu is open, touching the map will place a waypoint at the touched location. Figure 85 shows a sequence of 2 waypoints that have been placed. You can drag waypoints to move them around. You can touch the + button between two waypoints to add a new waypoint there. Touching a waypoint will select it and give you the option to delete it, as shown in Figure 86.

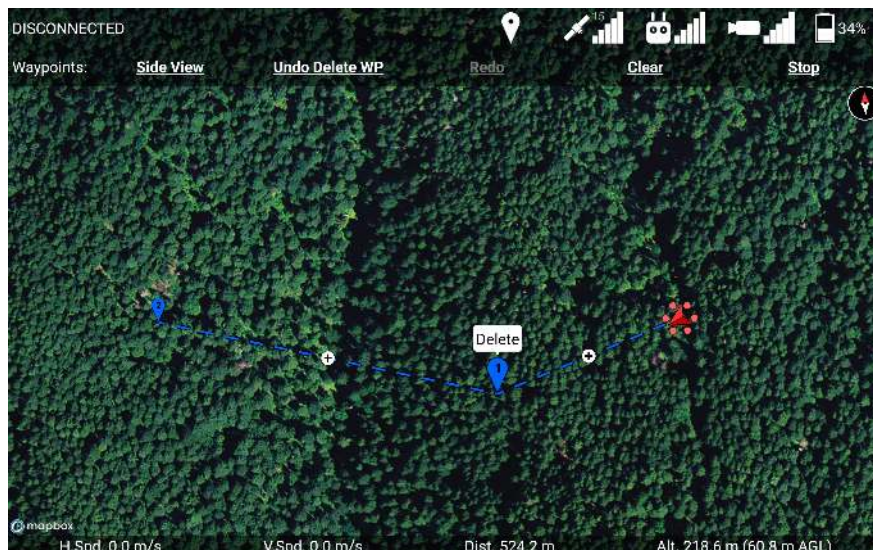

Figure 86: Touch a waypoint a waypoint to select it and make the delete bubble appear above it. Touch the delete bubble to delete that waypoint. Touch anywhere else to deselect it.

Touch the “Clear” button to remove all of the waypoints. The “Undo” and “Redo” buttons can be used to undo and redo adding, deleting, and clearing waypoints. If the drone is flying along a waypoint mission, then the “Stop” button will stop the mission and give you manual control of the drone again. You can also regain manual control of the drone by switching to mode P on the controller.



Figure 87: Side view of waypoint mission.

Touch the “Side View” button to see a side view of the waypoint mission, as shown in Figure 87. This side view shows the elevation of the terrain below the waypoint mission, with the brown area representing the ground. If you do not have an elevation map for this terrain, then the terrain will appear flat and at the same altitude as the takeoff location. The horizontal axis shows the distance along the waypoint mission, and the vertical axis shows the altitude above the takeoff location. The waypoint mission is “unrolled” in this view,

You can use your fingers to zoom and scroll around this view to get a better look at things. The light blue region above the ground is the airspace specified by the “Airspace indicator altitude” setting. The green zig-zag region is supposed to look like trees, and represents the airspace specified by the “Low altitude warning” setting. The thin red line at 500 meters altitude is the maximum flight altitude of the drone. You can adjust this in Drone Setup. The orange dotted line that follows the terrain is the snap altitude. Newly placed waypoints will be set to this altitude. To go back to the waypoints menu, touch the “Back” button.

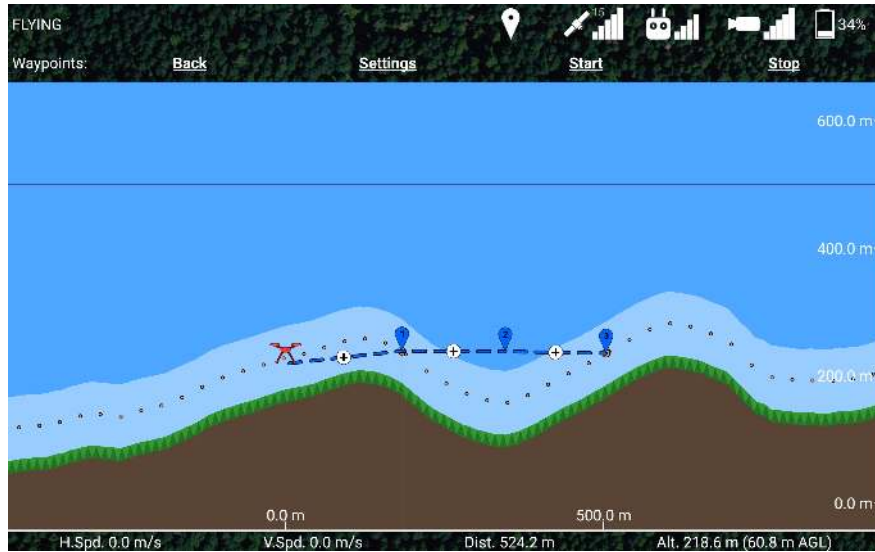

Figure 88: Touch the plus button in the middle of a waypoint path segment to create a new waypoint there.

If you touch the plus button in the middle of a waypoint segment, a new waypoint will be created there, as shown in Figure 88.

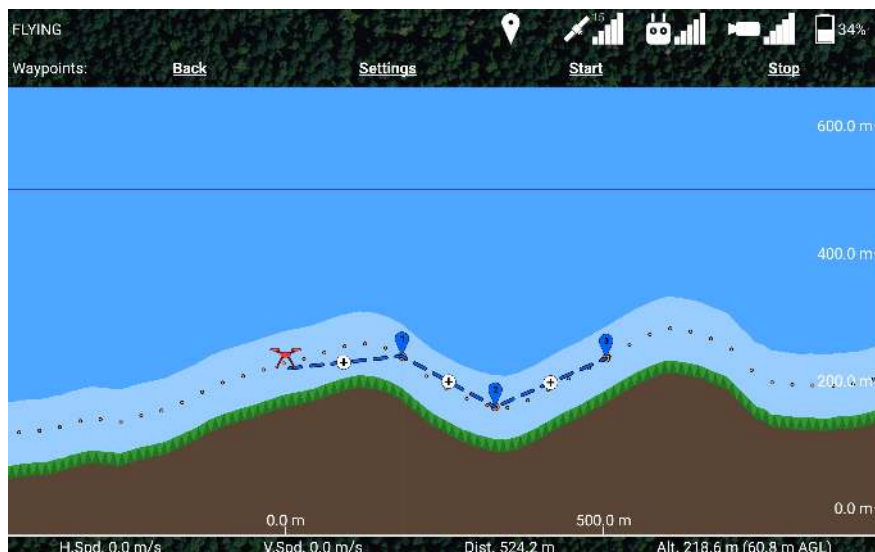

Figure 89: Drag waypoints in the side view to change their altitude.

You can drag the waypoints up and down in order to adjust their altitude, as shown in Figure 89. In this case, waypoint 2 was above our airspace restriction (light blue region), so we lowered it to be closer to the ground. When it was moved near the orange-dotted snap altitude line, its altitude was snapped to the snap altitude (represented by the larger orange dot appearing under the waypoint).

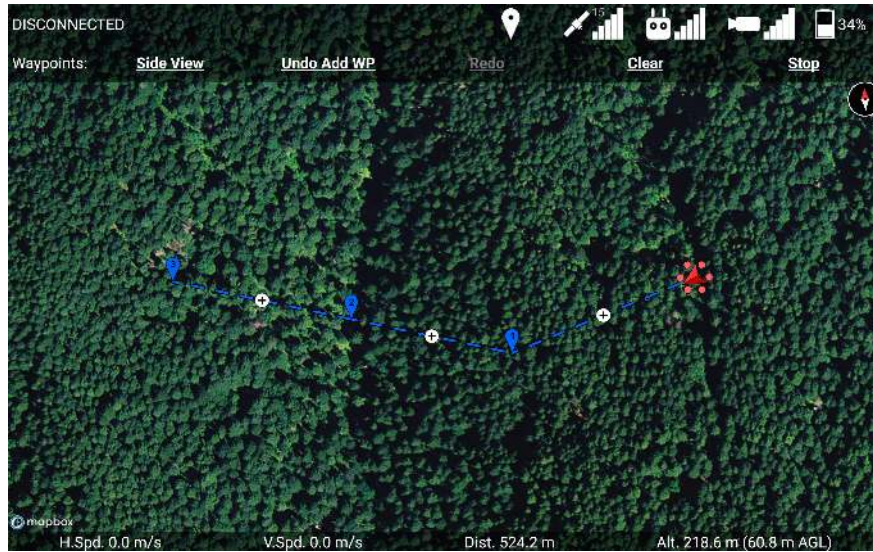

Figure 90: The path through waypoint 2 doesn't change heading, which allows you to move waypoint 2 left and right in the side view.

Because the newly-added waypoint 2 was added at the midpoint between waypoints 1 and 3, the path segments into and out of waypoint 2 are aligned in the same direction, as shown in Figure 90. The app doesn't require the waypoints to be perfectly aligned in order to move them left and right in the side view, so you'll be able to use this feature even if you drag the waypoints into a line with your finger in the top-down map view. Moving waypoint 2 left and right in the side view will move it closer to the previous waypoint (1) or closer to the following waypoint (3), but it will stay along the line that connects the two.

The waypoints that mark a turn in the waypoint mission have a thin, gray, vertical line going through them, indicating that the side view is unfolding a turn in the path here, and the waypoint can only be moved up and down.

Like in the top view, you can touch a waypoint to select it and make a delete bubble appear above it. Touch the delete bubble to delete the waypoint, or touch anywhere else to deselect it.

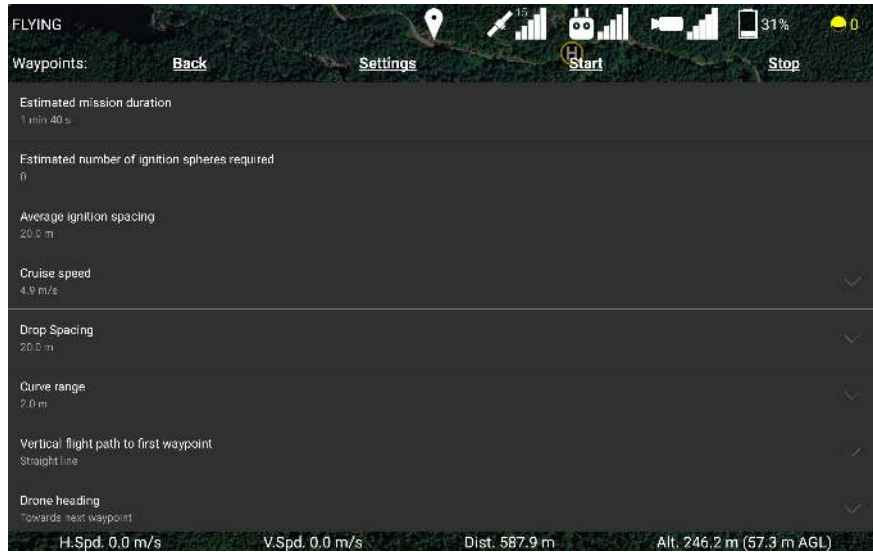

Figure 91: Waypoint mission settings.

Press the “Settings” button to configure other parameters of the waypoint mission, shown in Figure 91.

Estimated Mission Duration An estimate of how long it will take to fly the mission, given the current settings.

Estimated number of ignition spheres required An estimate of how many ignition spheres will be dropped during the mission.

Average ignition spacing An estimate of how far apart the ignition spheres will be spaced, on average.

Cruise speed The speed the drone will normally fly at on its way between waypoints. You can manually control the drone’s velocity during the waypoint mission by using the pitch joystick.

Time between ignition sphere drops (Ignis 1 only) How much time Ignis should wait between ignition sphere drops. This requires Ignis 1 firmware version 570 or higher.

Drop Spacing (Ignis 2 only) How far apart Ignis should try to drop ignition spheres. Ignis will automatically adjust its drop rate while you fly according to the drone’s speed to try and drop at a consistent spacing. However Ignis can’t drop faster than 0.5 seconds per sphere, or slower than 7 seconds per sphere.

Curve range This will make the drone follow a curved flight path. This is the distance from the waypoint the drone should start turning at. If a segment of the waypoint

mission is too short to support a curve range of this size, then the curve range will be shrunk for those waypoints. The drone will always stop at the first waypoint.

Vertical flight path to first waypoint The drone can either follow a straight-line path to the first waypoint, or follow a “Safe” path. If set to “Safe”, the drone will ascend to the waypoint’s altitude and then fly horizontally to the waypoint. If the drone is already above the first waypoint, it will instead fly horizontally until it is directly above the waypoint, and then descend to it.

Drone Heading Sets the yawing behavior of the drone when it reaches a waypoint. If set to “Towards next waypoint”, the drone will turn to face the next waypoint whenever it reaches a waypoint. If set to “Controlled by remote controller”, the drone will turn to face the first waypoint upon starting the mission, but will not automatically turn afterward. In either setting, the yaw of the drone can be manually adjusted by the remote controller whenever the drone is not automatically yawing.

Waypoint Mission Lost Link Procedure Sets the behavior of the drone when it loses the remote controller’s signal during the waypoint mission. You can either have it end the mission immediately and execute its lost link procedure, or continue the mission to completion and then execute its lost link procedure if the connection is not regained. Note that if you select the option to complete the mission, the drone will fly the path, but Ignis not drop anything until connection is regained.

Press the “Back” button again to return to the side view.

Once you are satisfied with the waypoint mission, press the “Start” button to upload the waypoint mission to the drone and begin flying it.

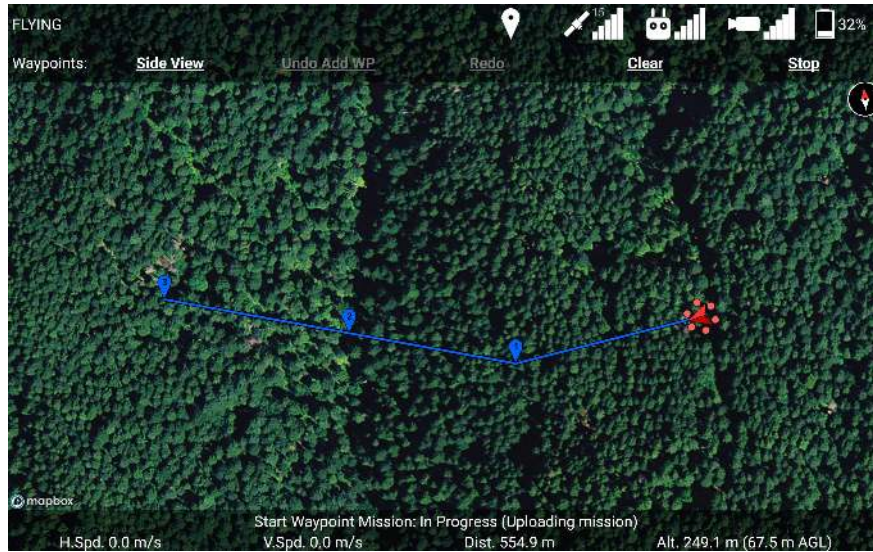

Figure 92: Uploading a waypoint mission.

The waypoint path will become solid instead of dashed to indicate it is being uploaded and executed, as shown in Figure 92. A status message will appear at the bottom of the screen to describe the status of the upload. If the upload fails, you can retry the upload by pressing the “Start” button again. Once the mission is done uploading, the drone will begin to fly along it, and its status will change from FLYING to WAYPOINTS.

You can press the “Stop” button to stop the drone from flying the waypoint mission and regain normal control.

You cannot modify the waypoint mission while it is uploading or executing. If you place new waypoints, the drone will not automatically fly to them unless you stop and restart the waypoint mission. Each waypoint will be automatically removed as the drone reaches it, allowing you to easily resume the waypoint mission if you stop it. The drone will hover in place once it reaches the last waypoint.

If you press the “Start” button while a waypoint mission is executing, the current mission will be stopped, and a new one will be started.

Due to limitations of the DJI Mobile SDK, the app can only infer that the drone is flying a waypoint mission based on the the success of the start and stop operations. It’s possible that a miscommunication could cause the app to display “WAYPOINTS” when the drone is not flying a waypoint mission. In this case, start a new waypoint mission and immediately stop it to make the app realize the drone is not flying a waypoint mission.

It’s also possible that the app could display “FLYING” even though the drone is following a waypoint mission. This could happen if the app is restarted while the drone is mid-mission. In this case, you can still use the “Stop” button to stop the mission.

7.10.8 Ignition Lines

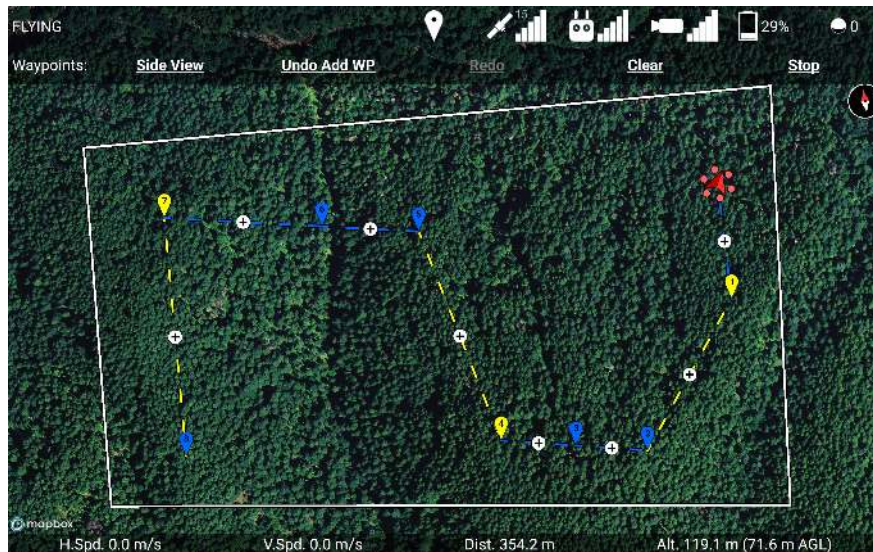

Figure 93: Touch dashed lines of the waypoint path to toggle dropping along that part. Ignis will drop ignition spheres along yellow lines.



Figure 94: You can also toggle dropping along lines by touching them in the side view.

The waypoints can also be used to control Ignis's dropping. Touch a dashed line along a waypoint mission to toggle it between yellow and blue, as shown in Figure 93 and Figure 94. Ignis will automatically start dropping when it reaches a yellow portion of the waypoint path, and will stop dropping when it reaches a blue portion of the waypoint path. The last waypoint is always blue, indicating that Ignis will automatically stop dropping at the end

of the waypoints. You cannot activate/deactivate a part of a waypoint path after that part has been uploaded and turned solid.

The waypoint settings menu in Figure 91 will display helpful information about the planned mission, such as the estimated number of ignition spheres required for the mission, and the average spacing between each ignition sphere. Adjust the cruise speed and drop spacing to achieve the desired distance between ignitions.

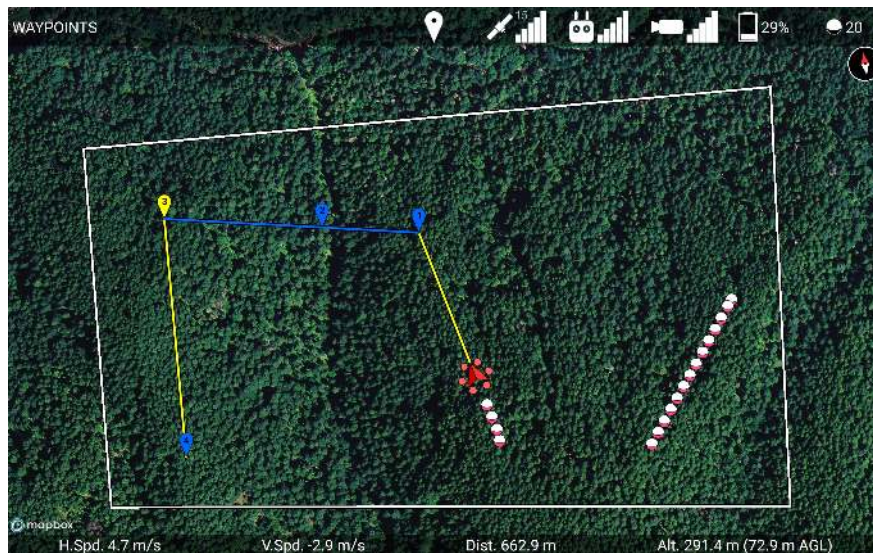

Figure 95: Dropping ignition spheres along a burn line.

Figure 95 shows the Ignis automatically dropping ignition spheres as the drone flies along these waypoints. Whenever the drone travels from a blue section of a waypoint mission to a yellow section, it will start dropping with Ignis, and whenever it travels from a yellow section to a blue section, or reaches the end of the waypoint mission, it will stop dropping. As a warning for users of Ignis 1, Ignis 1 can take several seconds to finish stopping, and during this period it ignores new start commands. As a consequence of this, if you have a short unactivated segment between two activated segments, Ignis may not start dropping on the second activated sequence because it was still in the stopping process. If Ignis doesn't start dropping automatically, you can always manually send the start command through the Ignis menu. Ignis will automatically stop at the end of the activated sequence.

7.11 Privacy Mechanisms

The privacy-enhanced version of the app has two mechanisms that prevent data leakage.

The first mechanism is a firewall that blocks all internet traffic that could leak data. The privacy-enhanced version of the app is actually divided into two Android applications. The

first application is the Launcher app, which does not include any DJI code, and is therefore safe to allow access to the internet. The second application is the Flight app, which is used to actually fly the drone, and therefore includes DJI code which could potentially leak data. The Launcher app creates a Virtual Private Network (VPN) service that blocks all internet traffic from the Flight app, effectively acting as a firewall. Since the Launcher creates a Virtual Private Network, this app is incompatible with other Virtual Private Network apps. Uninstall other VPN apps in order to ensure that the firewall functions properly. The firewall will automatically start after the device is booted, so the Flight app can be safely run even if the Launcher app hasn't been run first.

The second mechanism is a fail-safe in case the firewall is somehow compromised. This could happen if the DA Launcher app is uninstalled, or force-stopped. The Flight app makes a check 20 times a second that checks to see if the app can connect to the internet. If the Flight app detects an internet connection, it will immediately kill its process. This immediately kills the Ignis application and all of the services started by the DJI Mobile SDK, preventing any leakage of data.

8 Service and Maintenance

The Ignis system was designed with minimal maintenance requirements. Key to the longevity of the system is to regularly clean any dust or other buildups from the system and flushing the fluid reservoir system with clean water as outlined in the Section 4.6. We also recommend inspecting the needles for clogs or other damage before and after each flight and replacing them as needed. This section outlines additional maintenance procedures. Please contact Drone Amplified with any questions.

8.1 Every Flight Maintenance

Before and after every flight the needles should be removed and inspected for blockage and debris as detailed in 4.1.19. The needles can be cleaned and reused after using a thin rigid wire to remove any blockage. Eventually the custom-cut of the needle that prevents blockage may wear and the needle should be replaced. This should be done if a needle regularly collects debris buildup during flight.

8.2 Daily Maintenance

The post-flight checklist (Section 4.5) goes over all of the daily maintenance that is needed before storing. This includes:

- Flushing the fluid system with water and completely emptying it.
- Removing the Dropper and cleaning it well
- Clean all dust and ash from hopper
- Checking for damage.

8.3 Periodic Maintenance

8.3.1 Inspecting Screws



Figure 96: Replacement screws and drivers.

In addition to daily checks of the system when it is in use, we recommend a more detailed check of all screws and connections every 5-10 days of operation. During this more detailed inspection, look for any visibly loose or missing screws. In the screw kit provided with the system, shown in Figure 96, we provide the correct drivers and replacement screws for most screws. We do *not* recommend tightening screws if they are not visibly loose as over tightening can cause damage and could increase the chances of a screw coming loose as they are locked in place with threadlock during production. If a screw is missing or loose,

replace/tighten it. For screws inserted into plastic pieces, gently tighten until the parts are just snug. For screws inserted into aluminum pieces, we recommend applying medium strength threadlock, if available, and then tightening. If you have any questions or concerns on the length or type of screws please contact Drone Amplified.

8.3.2 Cleaning Dropper



Figure 97: Cleaning kit.

We provide a cleaning kit to clean the dropper that includes a brush, cotton swabs and dry lubricant. The frequency at which the dropper should be cleaned will vary greatly based on the operational conditions. We recommend cleaning at the end of each operational day to maintain proper working order.

Apply a small amount of the dry lubricant to the brush and cotton swabs to clean the Dropper wherever dirty, paying special attention to the bearings on the slipper block and tracks they run on. Additionally, clean the oval cutout on top of the dropper where the Hopper and Dropper mate shown in Figure 98.

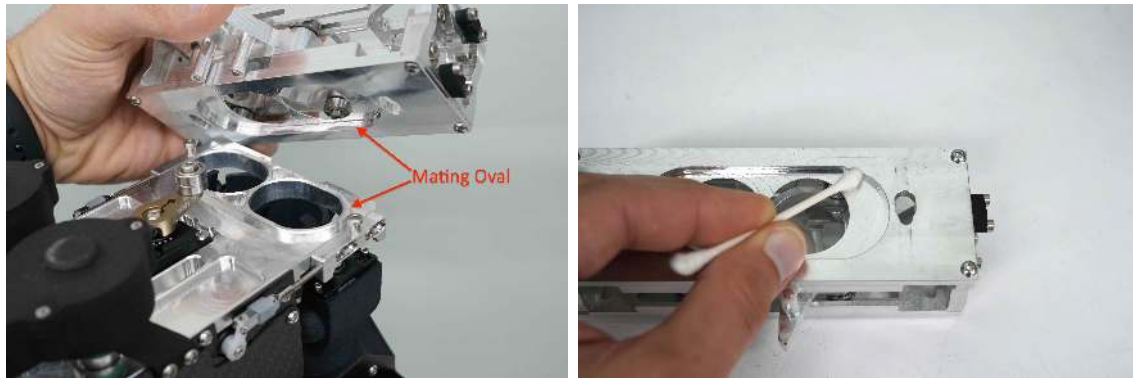

Figure 98: Clean the oval cutout where the Hopper and Dropper mate.

Build up of antifreeze or ash here could cause the Dropper to stick to the Hopper and not emergency release properly when triggered, allowing an in-flight fire to propagate to the rest of the drone.

Depending on the operating conditions, the Dropper may occasionally need to be partially disassembled to get completely clean. We recommend not doing this procedure in the field but rather as part of a regularly scheduled maintenance in a controlled environment where it is less likely small parts could be lost.

Using the 2.5mm driver included with IGNIS 2, remove the 4 socket head cap screws on top of the Dropper shown in Figure 99. The top of the dropper and the slipper block can both be removed and cleaned individually. A solution of hydrogen peroxide and vinegar will remove staining from potassium permanganate and compressed air can help clean out small crevices and corners. After cleaning is complete, a drop of dry lubricant on each bearing on the slipper block will prevent corrosion.

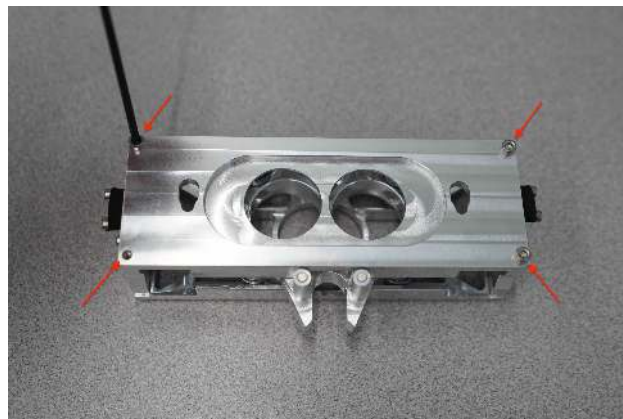

Figure 99: Remove four socket head cap screws with 2.5mm driver to disassemble and clean dropper.

To reassemble the dropper, slide the slipper block into the bearing tracks with the magnets facing up, then install the top plate with the small end of the teardrop shaped slots towards the magnets as shown in Figure 100. Finally, use a small amount of medium strength thread lock on each socket head cap screw and secure the Dropper top plate in place.

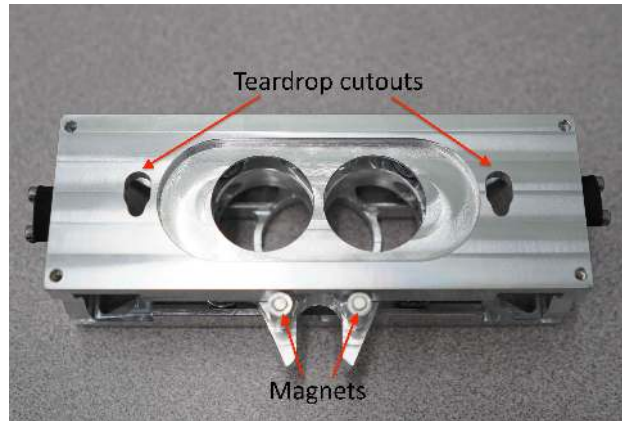

Figure 100: Install slipper block in bearing tracks with magnets up. Install top plate with the small end of the teardrop slots towards the magnets

8.3.3 Replacing A Needle

If a needle is broken or bent and needs to be replaced, you will need to remove the needle assembly to replace the needle. Unscrew the four screws that clamp the needle retainer over the needle, then remove the broken needle.



Figure 101: Slide the retainer over the new needle.

Slide the retainer over the new needle, as shown in Figure 101.



Figure 102: The needle can only fit through the rectangular hole in one orientation.

Slide the needle through the rectangular hole in the retainer, as shown in Figure 102.



Figure 103: Needle tabs aligned with the cutouts on the retainer.

Rotate the needle 45 degrees so that the tabs on the base of the needle fit in the cutouts on the needle retainer, as shown in Figure 103.



Figure 104: O-ring fully seated on needle mount.

Ensure the o-ring is fully seated on the needle mount and in good condition, as shown in Figure 104.



Figure 105: Needle hole oriented so that it will face downward when inserted in Ignis.

Place the needle and retainer on the needle mount and make sure that the side port hole of the needle will be oriented downward once installed in IGNIS, as shown in Figure 105. Incrementally tighten the screws until the retainer is fully seated on the needle mount.

9 Installation on DJI Matrice 600

Installing Ignis on a DJI Matrice 600 requires:

- Installing the external trigger on the DJI controller (Figure 34).
- Installing control cables to interface with the DJI system with Ignis.
- Configuring the DJI software to properly interface with Ignis.

Questions on the procedure or for guidance during the installation, please contact the Drone Amplified team.

9.1 DJI Channel Expansion Kit Installation

Ignis is controlled through a DJI Channel Expansion Kit, which is provided with the Ignis System. There are a variety of tutorials on how to install these onto the DJI controller. One such video can be found at <https://youtu.be/eyNJsgQTiMY>.

9.2 Interface Cables

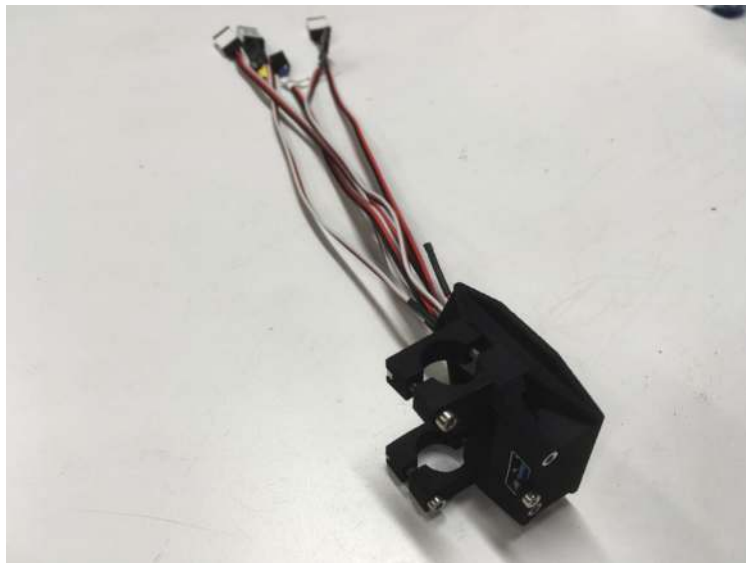

Figure 106: Interface cables for DJI.

Figure 106 shows the interface cables provided in the kit.



Figure 107: Unscrew top cover and remove bottom cover.

To install the control cables, start by removing the top and bottom cover on the Matrice 600 Pro as shown in Figure 107. The top cover requires the removal of six screws, while the bottom cover snaps on and can be removed by firmly pulling at the two labeled pull locations.

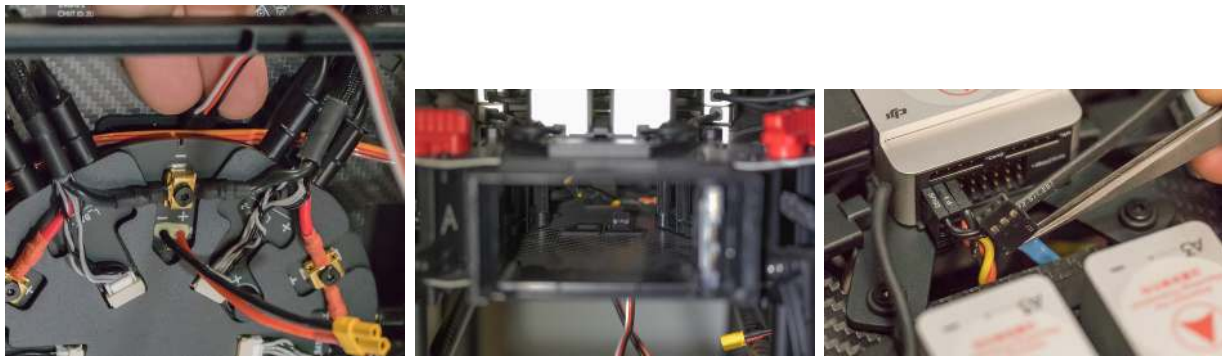

Figure 108: Inserting the yellow, green, and blue connectors through battery bay 1.

Next, locate the opening at the back of battery bay 1 and route the yellow, green, and blue 3-pin connectors from the bottom to the top of the Matrice as shown in Figure 108. It is easiest to use small tweezers to grab and manipulate the cables. Ensure that you do not push out the rubber grommets that protects the cables going through the carbon fiber.



Figure 109: Three connectors installed.

Next, plug in the three cables as shown in Figure 109. Make sure that the black wires on the connectors are all on the left. The yellow and green cables should be installed on the lower row of connectors labeled sBus (green on right, yellow on left). The blue cable should attach to the connector labeled API, with the white wire on the pin all the way right (note the 4th pin on the right if the header is unused). Incorrect connections could cause damage to the Matrice or Ignis.



Figure 110: Attach USB port to upper rail under battery bay 6.

Clamp the USB port attachment to the upper rail under battery bay 6 by unscrewing the four screws holding the tube clamps together, sliding the usb attachment into the proper place, and then screwing the tube clamps back together.



Figure 111: Ziptie the connectors in place.

Next, ziptie the connectors in place as shown in Figure 111. When doing so, we recommend first mounting the Ignis system to ensure that the connectors are in accessible locations. Make sure not to pinch the wires too tight with the zipties. The connectors to the Ignis should be on the front of the Matrice 600 between battery bays 1 and 6. We recommend securing the extra PWM connectors at the rear of the vehicle between battery bays 4 and 5.

Finally, put the top and bottom covers back on the Matrice 600. Pay special attention to not pinch any wires when replacing the covers. In particular, the new Ignis communication wires should be routed through existing openings in the bottom case.

9.3 DJI Software Configuration

Download and install DJI Assistant 2 (which is required to activate the DJI Matrice 600 before the first flight). Connect the vehicle to your computer using a USB cable, and turn it on. Then select the Matrice 600 in the “Connected Devices” screen of DJI Assistant 2.

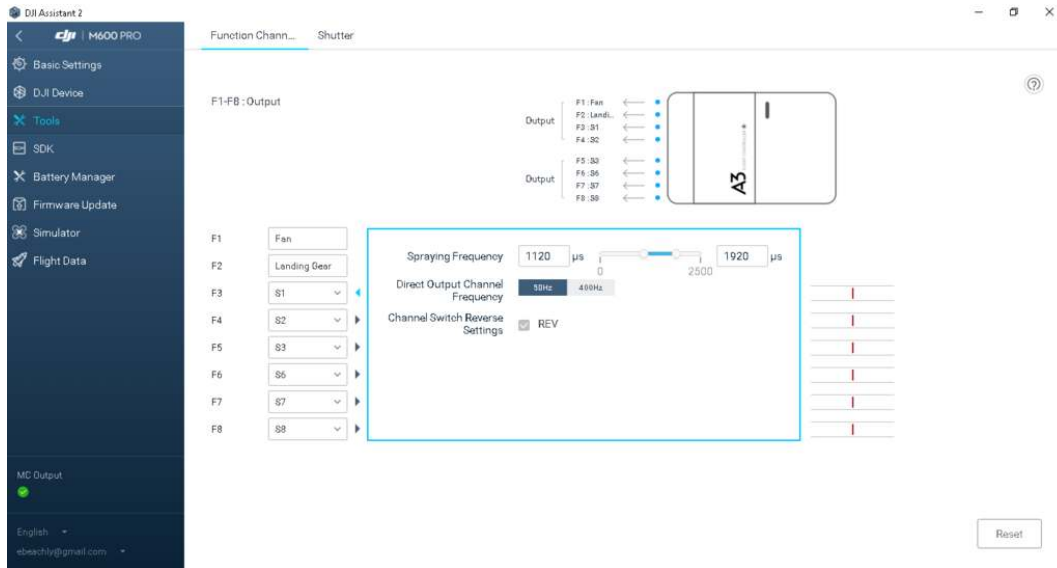

Figure 112: DJI Matrice 600 PWM Output Configuration.

Next, go to the Tools tab, shown in Figure 112. Using the dropdown boxes configure: F3 to connect to S1; F4 to connect to S2; F5 to connect to S3; F6 to connect to S6; F7 to connect to S7; F8 to connect to S8; The “Spraying Frequency” and “Output Channel Frequency” parameters should be configured to their defaults, as shown in the figure.

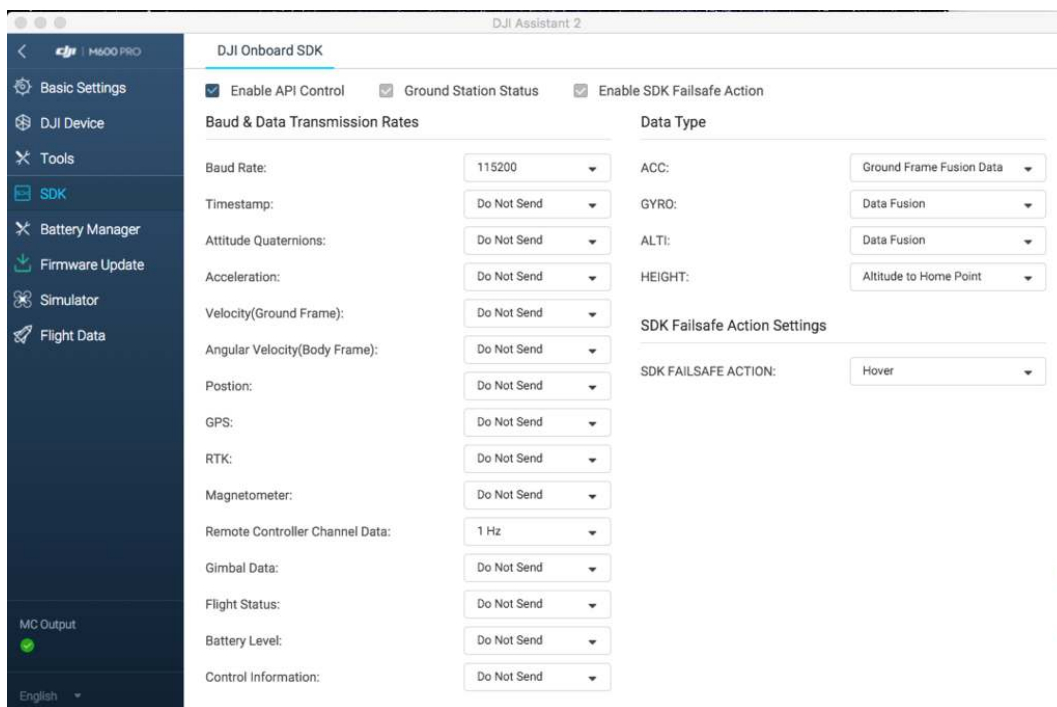

Figure 113: DJI Matrice 600 Onboard SDK Configuration.

Next, go to the SDK tab, shown in Figure 113. Select the “Enable API Control” box (Note, on some versions of the DJI software it is very hard to tell if this is selected or not, so try toggling it to select the on state). Configure the Baud Rate to 115200. Set the “Remote Controller Channel Data to 1Hz. The rest of the settings should be configured to “Do Not Send” as shown in the figure.

Restart the Matrice 600 to apply these changes.

9.4 DJI Onboard SDK Activation

Finally, the Matrice 600 needs to perform another activation in order to be able to forward messages from Ignis to the Android app. This procedure needs to be performed once with each vehicle that will be used to carry Ignis.

Power Ignis on and connect it to the Matrice 600, and turn the Matrice 600 on. Setup Ignis via Bluetooth in the app, and read the status on the right side of the screen.

If it says No OnboardSDK Activation Result, or doesn’t show the Drone Protocol Version, double check that the drone is on and Ignis is connected to it.

If the Matrice 600 has not performed the Onboard SDK activation, you will see an error as in Figure 114. You’ll see this error on drones you haven’t used with Ignis before, or since their last firmware update.



Figure 114: Error message displayed when the Matrice 600 has not performed the DJI Onboard SDK Activation with Ignis

The error in Figure 114 tells you to connect the drone to DJI Assistant 2. Connect the Matrice 600 to DJI Assistant 2 again, and make sure your computer is connected to the internet. Ignis will automatically perform the activation. When it is successful, you will see a message as in Figure 115.



Figure 115: Message displayed when the DJI Onboard SDK is Successfully Activated

If it is unsuccessful, you will instead see an error message on this screen. If it says that DJI Assistant could not connect to the internet, check your computer's internet connection. If it says no response from DJI Assistant 2, check the connection between the drone and your computer, and your internet connection. If you are getting a different error, retry this processes, then contact Drone Amplified for support.

After the activation was successful, you won't need to do this again until you update the Matrice 600's firmware. You can verify the activation was successful by starting the Drone Amplified app and connecting it to the vehicle's remote controller. Make sure the app was able to connect to the drone, then press the FLY button to open up the flight activity, as shown in Figure 32. Touch the ignition sphere icon in the top right to view the Ignis's status. If it shows IDLE, then the activation was successful.

If the app shows DISCONNECTED, check that Ignis will not be damaged by an emergency release, then try to command an emergency release through the app. If Ignis did perform an emergency release, but you still see a DISCONNECTED status, then the Matrice was not successfully activated to use Ignis. If Ignis didn't do anything, double-check

that Ignis is powered-on and connected to the vehicle properly.

You have now completed the setup. Connect and test Ignis with the Matrice 600. You should test the configuration by going through the normal procedures without spheres to ensure that Ignis can be properly controlled from the DJI controller.